

**DiGiTech**  
by HARMAN®

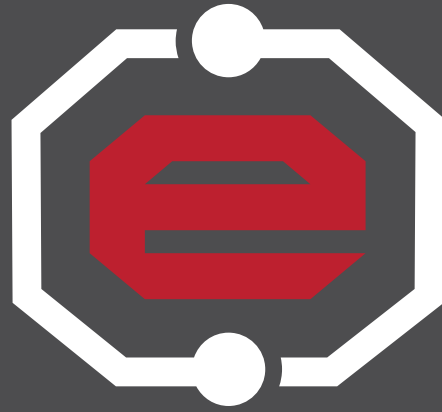

**ELEMENT**  
GUITAR EFFECT PROCESSORS



**Element / Element XP  
Owner's Manual**

# IMPORTANT SAFETY INSTRUCTIONS

## WARNING FOR YOUR PROTECTION

### READ THE FOLLOWING:

KEEP THESE INSTRUCTIONS

HEED ALL WARNINGS

FOLLOW ALL INSTRUCTIONS

The apparatus shall not be exposed to dripping or splashing liquid and no object filled with liquid, such as vases, shall be placed on the apparatus.

CLEAN ONLY WITH A DRY CLOTH.

FOR INDOOR USE ONLY.

DO NOT BLOCK ANY OF THE VENTILATION OPENINGS. INSTALL IN ACCORDANCE WITH THE MANUFACTURER'S INSTRUCTIONS.

DO NOT INSTALL NEAR ANY HEAT SOURCES SUCH AS RADIATORS, HEAT REGISTERS, STOVES, OR OTHER APPARATUS (INCLUDING AMPLIFIERS) THAT PRODUCE HEAT.

ONLY USE ATTACHMENTS/ACCESSORIES SPECIFIED BY THE MANUFACTURER.

UNPLUG THIS APPARATUS DURING LIGHTNING STORMS OR WHEN UNUSED FOR LONG PERIODS OF TIME.

Do not defeat the safety purpose of the polarized or grounding-type plug. A polarized plug has two blades with one wider than the other. A grounding type plug has two blades and a third grounding prong. The wide blade or third prong are provided for your safety. If the provided plug does not fit your outlet, consult an electrician for replacement of the obsolete outlet.

Protect the power cord from being walked on or pinched particularly at plugs, convenience receptacles, and the point where they exit from the apparatus.

Use only with the cart stand, tripod bracket, or table specified by the manufacture, or sold with the apparatus. When a cart is used, use caution when moving the cart/apparatus combination to avoid injury from tip-over.



Refer all servicing to qualified service personnel. Servicing is required when the apparatus has been damaged in any way, such as power-supply cord or plug is damaged, liquid has been spilled or objects have fallen into the apparatus, the apparatus has been exposed to rain or moisture, does not operate normally, or has been dropped.

**POWER ON/OFF SWITCH:** The Power switch used in this piece of equipment DOES NOT break the connection from the mains.

**MAINS DISCONNECT:** The plug shall remain readily operable. For rack-mount or installation where plug is not accessible, an all-pole mains switch with a contact separation of at least 3 mm in each pole shall be incorporated into the electrical installation of the rack or building.

If connected to 240V supply, a suitable CSA/UL certified power cord shall be used for this supply.

### WARNING:

- APPARATET MÅ TILKOPLES JORDET STIKKONTAKT.
- APPARATEN SKALL ANSLUTAS TILL JORDAT UTTAG.
- LAITE ON LIITETTÄVÄ SUOJAKOSETTIMITILLA VARUSTETTUUN PISTORASIAAN.

## DECLARATION OF CONFORMITY

Manufacturer's Name: DigiTech  
Manufacturer's Address: 8760 S. Sandy Parkway  
Sandy, Utah 84070, USA

declares that the product:

Product name: ELEMENT and ELEMENT XP

Product option: all (requires Class II power adapter that conforms to the requirements of EN60065, EN60742, or equivalent.)

conforms to the following Product Specifications:

Safety: IEC 60065 -01+Amd 1

EMC: EN 55022:2006  
EN 55024:1998  
FCC Part 15

Supplementary Information:

The product herewith complies with the requirements of the:  
Low Voltage Directive 2006/95/EC  
EMC Directive 2004/108/EC.  
RoHS Directive 2011/65/EC  
WEEE Directive 2002/96/EC  
EC Regulation 278/2009

With regard to Directive 2005/32/EC and EC Regulation 1275/2008 of 17 December 2008, this product is designed, produced, and classified as Professional Audio Equipment and thus is exempt from this Directive.

Rex C. Reed  
Director, Engineering  
Signal Processing  
8760 S. Sandy Parkway  
Sandy, Utah 84070, USA  
Date: July 9, 2013

European Contact: Your local DigiTech Sales and Service Office or

Harman Signal Processing  
8760 South Sandy Parkway  
Sandy, Utah  
84070 USA  
Ph: (801) 566-8800  
Fax: (801) 568-7583

# IMPORTANT SAFETY INSTRUCTIONS

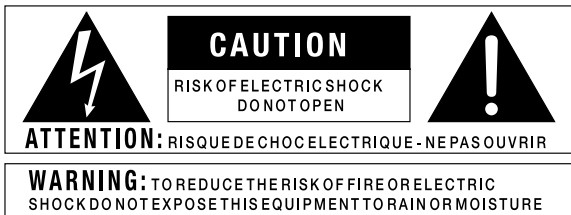

The symbols shown above are internationally accepted symbols that warn of potential hazards with electrical products. The lightning flash with arrowpoint in an equilateral triangle means that there are dangerous voltages present within the unit. The exclamation point in an equilateral triangle indicates that it is necessary for the user to refer to the owner's manual.

These symbols warn that there are no user serviceable parts inside the unit. Do not open the unit. Do not attempt to service the unit yourself. Refer all servicing to qualified personnel. Opening the chassis for any reason will void the manufacturer's warranty. Do not get the unit wet. If liquid is spilled on the unit, shut it off immediately and take it to a dealer for service. Disconnect the unit during storms to prevent damage.

The following is indicative of low altitude use; do not use this product above 2000m.



## ELECTROMAGNETIC COMPATIBILITY

This device complies with part 15 of the FCC Rules and the Product Specifications noted on the **Declaration of Conformity**. Operation is subject to the following two conditions:

- this device may not cause harmful interference, and
- this device must accept any interference received, including interference that may cause undesired operation.

Operation of this unit within significant electromagnetic fields should be avoided.

- use only shielded interconnecting cables.



If you want to dispose this product, do not mix it with general household waste. There is a separate collection system for used electronic products in accordance with legislation that requires proper treatment, recovery and recycling.

Private households in the 25 member states of the EU, in Switzerland and Norway may return their used electronic products free of charge to designated collection facilities or to a retailer (if you purchase a similar new one).

For Countries not mentioned above, please contact your local authorities for a correct method of disposal.

By doing so you will ensure that your disposed product undergoes the necessary treatment, recovery and recycling and thus prevent potential negative effects on the environment and human health.

# Warranty

We at **DigiTech**® are very proud of our products and back-up each one we sell with the following warranty:

1. Please register online at [digitech.com](http://digitech.com) within ten days of purchase to validate this warranty. This warranty is valid only in the United States.
2. DigiTech warrants this product, when purchased new from an authorized U.S. DigiTech dealer and used solely within the U.S., to be free from defects in materials and workmanship under normal use and service. This warranty is valid to the original purchaser only and is non-transferable.
3. DigiTech liability under this warranty is limited to repairing or replacing defective materials that show evidence of defect, provided the product is returned to DigiTech WITH RETURN AUTHORIZATION, where all parts and labor will be covered up to a period of one year. A Return Authorization number may be obtained by contacting DigiTech. The company shall not be liable for any consequential damage as a result of the product's use in any circuit or assembly.
4. Proof-of-purchase is considered to be the responsibility of the consumer. A copy of the original purchase receipt must be provided for any warranty service.
5. DigiTech reserves the right to make changes in design, or make additions to, or improvements upon this product without incurring any obligation to install the same on products previously manufactured.
6. The consumer forfeits the benefits of this warranty if the product's main assembly is opened and tampered with by anyone other than a certified DigiTech technician or, if the product is used with AC voltages outside of the range suggested by the manufacturer.
7. The foregoing is in lieu of all other warranties, expressed or implied, and DigiTech neither assumes nor authorizes any person to assume any obligation or liability in connection with the sale of this product. In no event shall DigiTech or its dealers be liable for special or consequential damages or from any delay in the performance of this warranty due to causes beyond their control.

**NOTE:** The information contained in this manual is subject to change at any time without notification. Some information contained in this manual may also be inaccurate due to undocumented changes in the product since this version of the manual was completed. The information contained in this version of the owner's manual supersedes all previous versions.

# Service Contact Info

If you require technical support, contact DigiTech Technical Support. Be prepared to accurately describe the problem. Know the serial number of your device—this is printed on a sticker attached to the chassis. If you have not already taken the time to register your product, please do so now at [digitech.com](http://digitech.com).

Before you return a product to the factory for service, we recommend you refer to the manual. Make sure you have correctly followed installation steps and operating procedures. For further technical assistance or service, please visit our support page at [digitech.com](http://digitech.com). If you need to return a product to the factory for service, you **MUST** first contact Technical Support to obtain a Return Authorization Number.

No returned products will be accepted at the factory without a Return Authorization Number.

Please refer to the Warranty information, which extends to the first end-user. After expiration of the warranty, a reasonable charge will be made for parts, labor, and packing if you choose to use the factory service facility. In all cases, you are responsible for transportation charges to the factory. DigiTech will pay return shipping if the unit is still under warranty.

Use the original packing material if it is available. Mark the package with the name of the shipper and with these words in red: DELICATE INSTRUMENT, FRAGILE! Insure the package properly. Ship prepaid, not collect. Do not ship parcel post.

# Table of Contents

<b>Overview .....</b>	<b>2</b>	<b>The Effects .....</b>	<b>25</b>
Introduction .....	2	Wah (Element XP Only) .....	25
Features .....	3	Compressor .....	25
<b>User Interface &amp; Connectors .....</b>	<b>4</b>	Amp/Distortion Models .....	26
Top Panel .....	4	EQ .....	27
Rear Panel .....	6	Noise Gate.....	27
<b>Connection Diagrams .....</b>	<b>8</b>	Mod FX .....	28
Mono Amp Configuration .....	8	Reverb .....	31
Stereo Amp Configuration .....	9	<b>Element Preset List .....</b>	<b>32</b>
Stereo Recording Configuration.....	10	<b>Element XP Preset List .....</b>	<b>33</b>
Headphone/Practice Configuration.....	11	<b>Technical Information .....</b>	<b>34</b>
<b>Operation .....</b>	<b>12</b>	Factory Restore .....	34
Modes Explained .....	12	Specifications.....	35
Play Mode.....	12		
Edit Mode.....	12		
Navigating Presets .....	13		
Editing Presets.....	13		
Selecting A Tone Bank.....	14		
Selecting An FX Bank.....	15		
Editing Effects.....	16		
Turning Effects On & Off.....	16		
Storing/Copying Presets .....	17		
Bypassing All Effects .....	18		
Using The Drum Machine.....	18		
Using The Tuner.....	20		
<b>Setup .....</b>	<b>21</b>		
Mono/Stereo Operation.....	21		
Speaker Cabinet Compensation (SCC) .....	21		
Expression Pedal Calibration (Element XP Only) ....	22		
Expression Pedal Assignment (Element XP Only) ...	23		

# Overview

## **Introduction**

The Element and Element XP provide a compact and cost-effective guitar effects processing solution. But don't let that fool you. The Element Series processors offer a powerful effects processing platform and complete feature set, so you can tantalize your creativity, improve your chops, and explore the endless possibilities of guitar effects, all with one simple-to-use, compact device.

The Element has 31 effects to choose from and allows you to run 8 effects simultaneously. The Element XP has 37 effects to choose from and allows you to run 9 effects simultaneously. The Element XP adds an Expression Pedal. Use it to control the Wah or Whammy™ effect or assign it to the effect you want to control for real-time effect changes with your foot.

100 included factory presets allow you to begin exploring immediately and 100 user presets allow you to store all your favorite sounds. Select between the 20 pre-configured FX Banks and Tone Banks to explore a multitude of tonal possibilities without even editing any effects!

The built in tuner ensures your guitar is in tune and the built-in drum machine and aux input jack allow you to play along with a drum loop, metronome, or your favorite music, so you can improve your skills fast and have fun doing it!

Whether you're a budding artist, or an experienced guitar aficionado, you'll have fun exploring the vast sound-shaping options available in the Element and Element XP. Thanks for choosing DigiTech®.

## **Features**

- 37 Effects (Element XP) / 31 Effects (Element)
- 12 Amp & 6 Distortion Models To Choose From
- Built-In Drum Machine With 45 Drum Pattern Loops Including Metronome
- Built-In Tuner
- Built-In Expression Pedal (Element XP Only)
- 200 Presets (100 User Presets / 100 Factory Presets)
- 9 Simultaneous Effects (Element XP) / 8 Simultaneous Effects (Element)
- 20 FX Banks & 20 Tone Banks To Choose From
- Mono / Stereo Output
- Aux Input For Playing Along With Your Favorite Songs
- 1/8" Headphone Output
- Speaker Cabinet Compensation
- Heavy Duty Metal Footswitches
- Power Supply Included

# User Interface & Connectors

## Top Panel

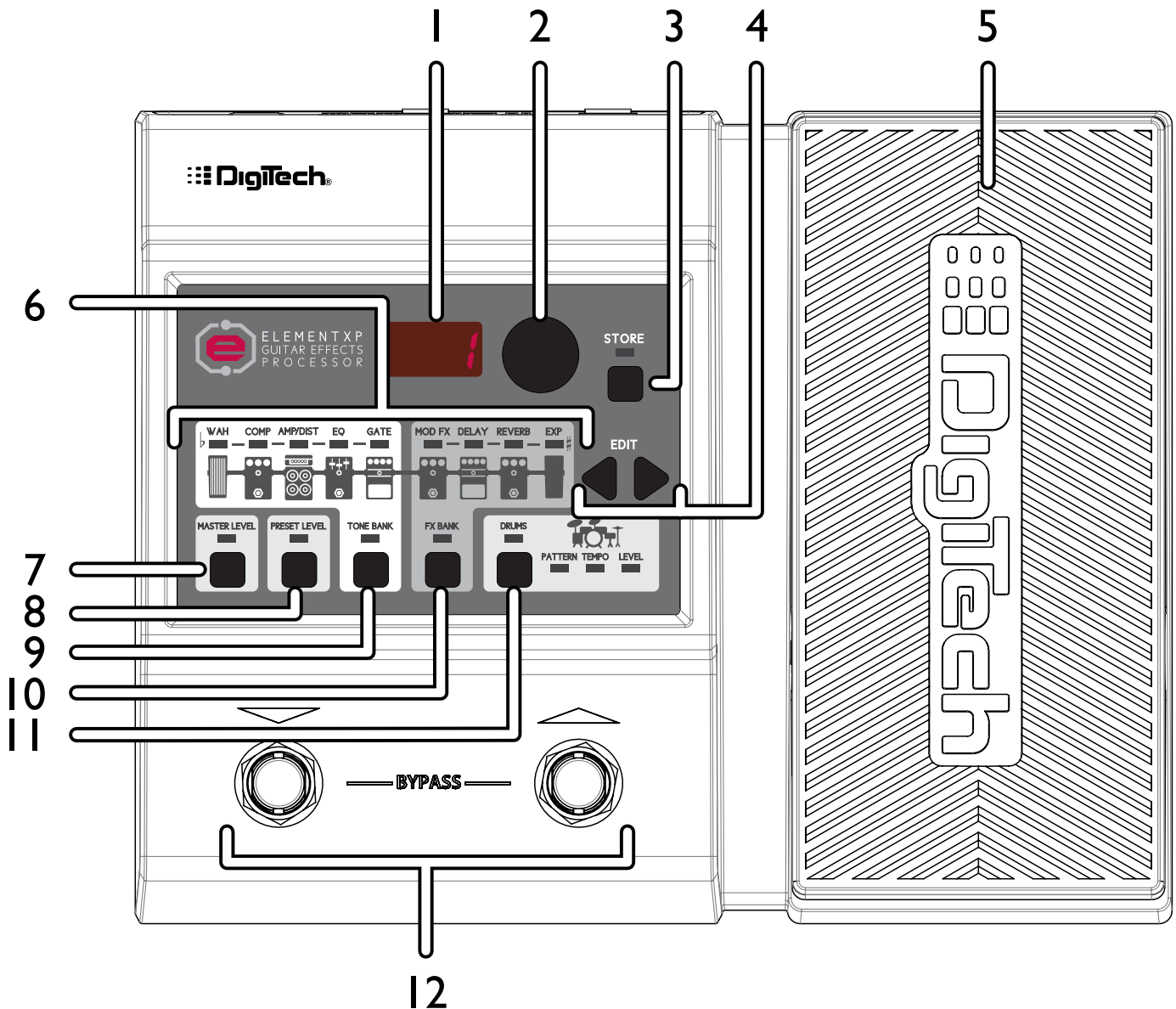

### 1. LED DISPLAY

This display shows the preset numbers when navigating presets (in Play Mode) and effect settings when editing (in Edit Mode).

### 2. SELECT KNOB

This knob serves as both a preset selector and editing control. In Preset Mode, turning this knob will change between presets. In Edit Mode, this knob will modify the currently selected effect or option.

### 3. STORE BUTTON

This button is used to store and copy presets to the 100 user preset memory locations. The **STORE LED** will light whenever a preset's stored effect settings are altered, indicating that the changes must be stored to a preset to be retained.



#### 4. **EDIT BUTTONS**

These left/right arrow buttons access effects and drum machine settings for editing.

#### 5. **EXPRESSION PEDAL (Element XP only)**

The Expression Pedal is used to control effects in real time. A single effect can be controlled by the expression pedal per preset.

#### 6. **EFFECTS CHAIN**

These icons provide a graphical representation of the internal effect signal chain used in the Element/Element XP. The signal flow is from left to right and offers effects like Wah (Element XP only), Compressor, Amp Modeling/Distortion, EQ, Noise Gate, Mod FX, Delay, and Reverb. The Element XP also has an option for setting up its built-in Expression Pedal to control a variety of these effects. The LED above each of the icons indicates whether each effect is on or off and which effect is selected when editing. These effect LEDs are also used to help you tune your guitar when using the built-in tuner (see "Using The Tuner" on page 20).

#### 7. **MASTER LEVEL BUTTON**

Press this button then turn the **SELECT** knob to adjust the Master Level. This will adjust the global output level for the Main and Headphone Outputs and will affect all presets.

#### 8. **PRESET LEVEL BUTTON**

Press this button then turn the **SELECT** knob to adjust the Preset Level. Preset Level is a programmable level that is stored with each preset and provides a quick way to balance volume between presets. Note that changes made to this parameter must be stored to the preset in order to be retained (see "Storing/Copying Presets" on page 17).

#### 9. **TONE BANK BUTTON**

This button is used to select from a preset library of 20 different clean and distorted tone configurations utilizing the Wah (Element only), Compressor, Amp/Distortion Modeling, EQ, and Noise Gate effect modules. Press this button then use the **SELECT** knob to select from a variety of genre-based amp tone defaults ranging from Blues to Metal to Country. See "Selecting A Tone Bank" on page 14 for more information on Tone Banks.

#### 10. **FX BANK BUTTON**

This button is used to select from a preset library of 20 different effect configurations utilizing the Mod FX, Delay, and Reverb effect modules. Press this button then turn the **SELECT** knob to select a variety of post-amplifier model effect chains (Chorus, Chorus + Delay, Delay + Reverb, etc.). See "Selecting An FX Bank" on page 15 for more information on Tone Banks.

#### 11. **DRUMS BUTTON**

Pressing this button toggles the internal drum machine on and off.

#### 12. **FOOTSWITCHES**

These footswitches are used for preset up/down navigation, bypass, and tuner activation.

## Rear Panel

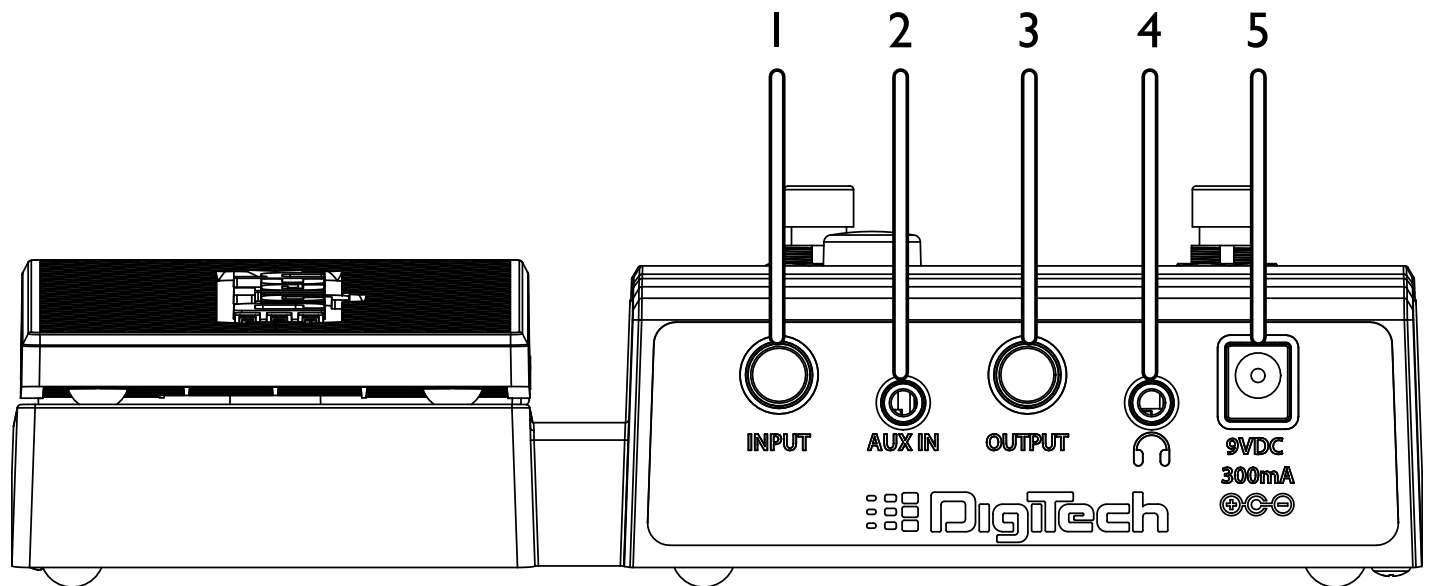

### **1. INPUT**

Connect your guitar to this high impedance 1/4" instrument input.

### **2. AUX IN**

Using a stereo 1/8" cable, connect the headphone output of a portable music or CD player to this 1/8" TRS jack to play along with all your favorite music. Adjust the output level of your playback device and the Element/Element XP's Master Level to achieve the proper mix balance.

### **3. MAIN OUTPUT**

This 1/4" TRS jack supports mono or stereo operation. Connect this output jack to your guitar amplifier using a mono instrument cable or connect to stereo inputs of a mixer or recording device using a stereo Y cable (see "Connection Diagrams" on page 8 for further information). The Master Level controls the global level of this output.

**NOTE:** Mono/stereo operation for the Main and Headphone Output jacks is determined by whether a plug is connected to the Main Output jack. If a plug is connected to this output jack, all outputs are set to mono for amp use. If no plug is connected to this jack, all outputs default to stereo for headphone use. This 1/4" Main Output can be forced to operate as a stereo output for stereo setups, see "Connection Diagrams" on page 8 and "Mono/Stereo Operation" on page 21 for more information.

### **4. HEADPHONE OUTPUT**

Connect your headphones to this 1/8" mini TRS jack. This output is optimized for use with headphones having an impedance of 60 Ohms or less. The Master Level controls the global level of this output.

**NOTE:** When only the headphones are connected, Speaker Cabinet Compensation (SCC) will be enabled to make the audio sound like it is actually being played through an amplifier. When a plug is connected to the 1/4" Main Output, SCC is disabled in the Headphone Output and all outputs are set for mono operation. See "Speaker Cabinet Compensation (SCC)" on page 21 and "Mono/Stereo Operation" on page 21 for more information.

## **5. POWER JACK**

Connect the included PS0913DC power supply to this power input jack.

# Connection Diagrams

Before connecting the Element/Element XP processor to an amplifier, it is recommended that you turn down the amplifier's master volume control and make sure that the power to your amplifier and the Element/Element XP are turned off. To turn the Element/Element XP on or off, connect or disconnect the included power supply from the **POWER** input jack. Once all is connected and powered on, you can then gradually increase your amplifier's master volume control until the desired level is achieved.

## Mono Amp Configuration

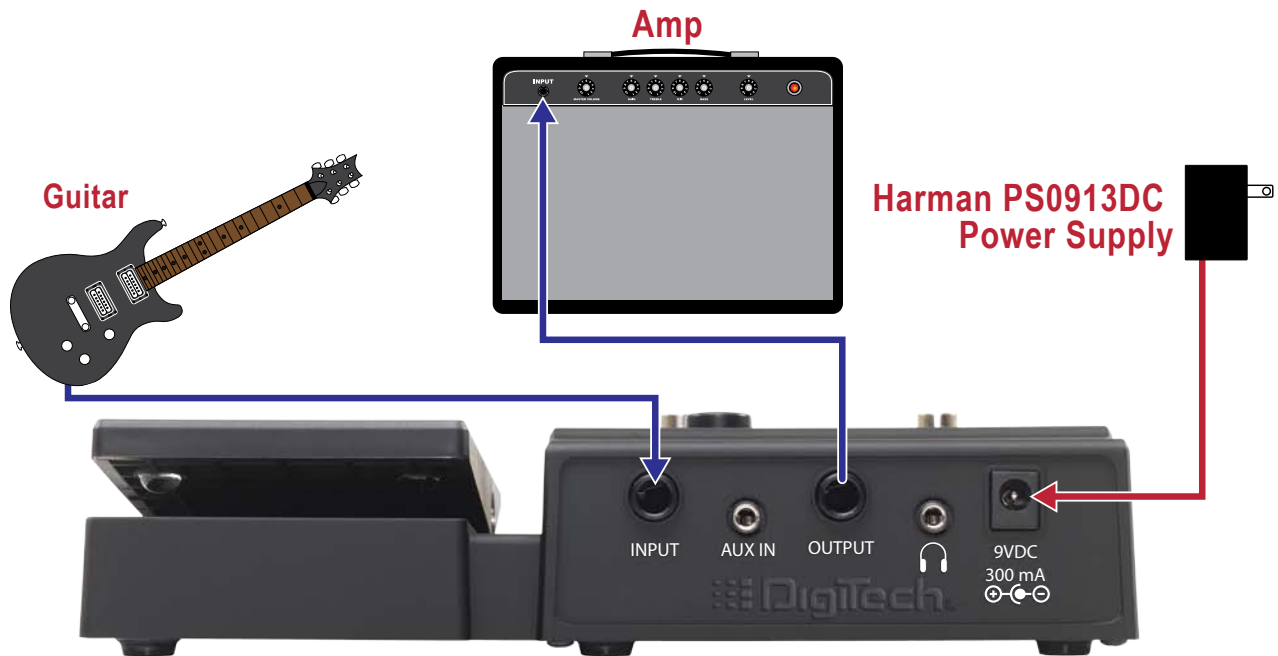

1/4" Mono Cable →

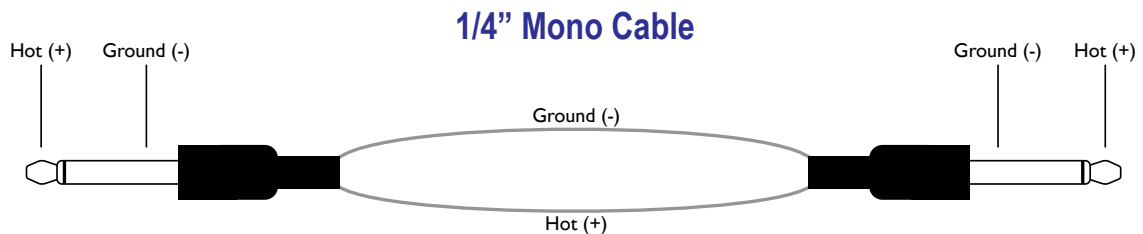

# Stereo Amp Configuration

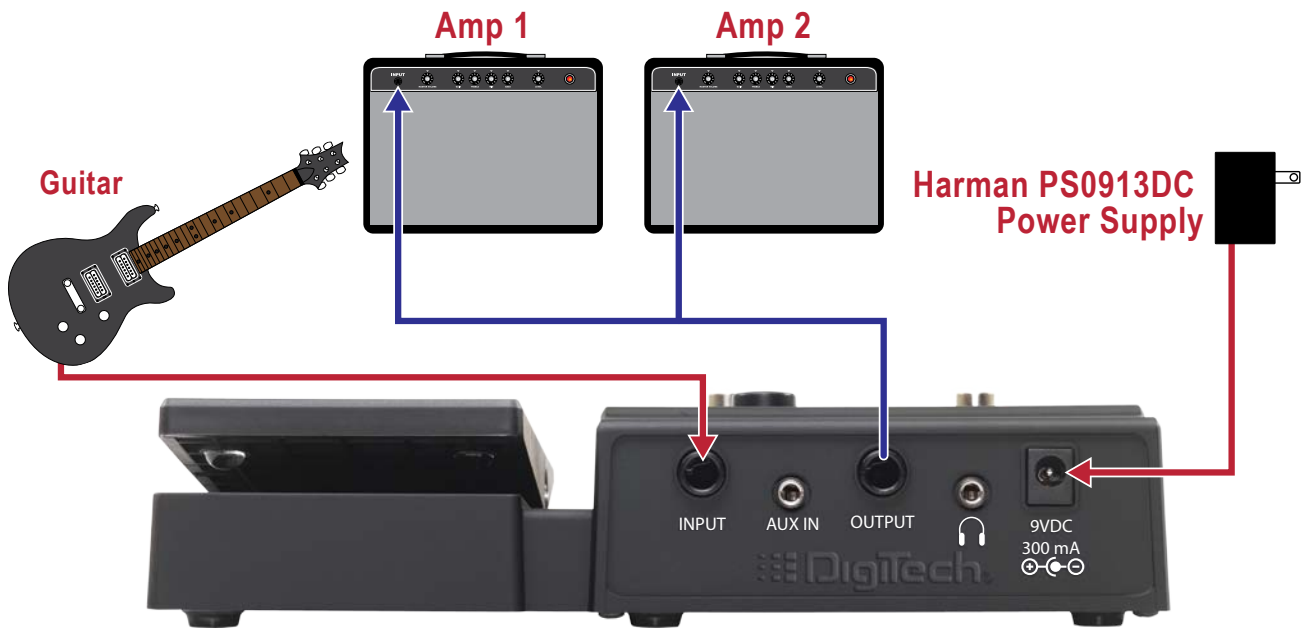

1/4" Stereo Y Cable →

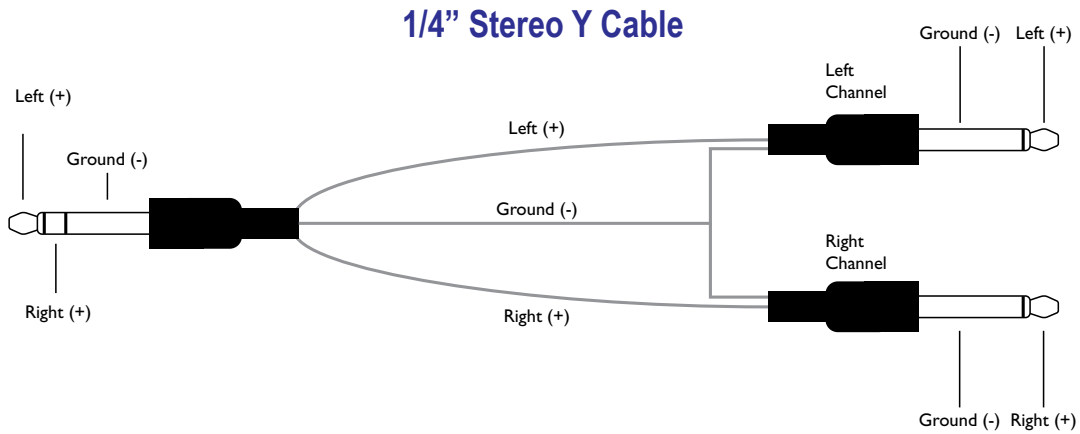

**NOTE:** The 1/4" Output must be configured for stereo operation for this type of setup. See "Mono/ Stereo Operation" on page 21 for more information.

# Stereo Recording Configuration

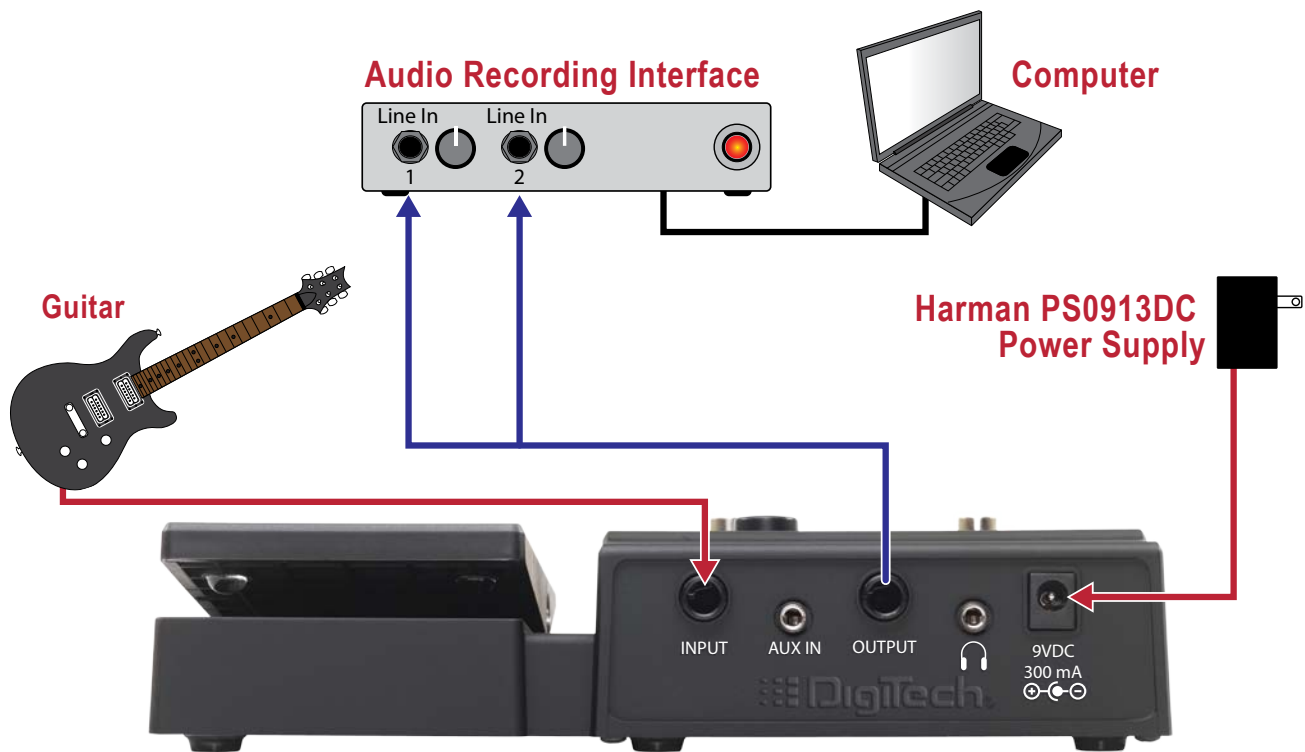

1/4" Stereo Y Cable   
 FireWire or USB 

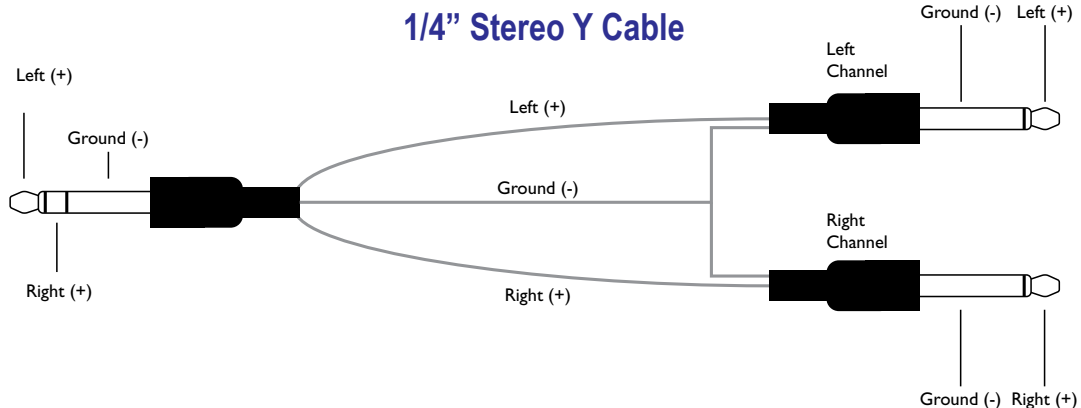

**NOTE:** The 1/4" Output must be configured for stereo operation for this type of setup. See "Mono/ Stereo Operation" on page 21 for more information. When connecting directly to a recording device, SCC must be enabled. See "Speaker Cabinet Compensation (SCC)" on page 21 for more information.

# Headphone/Practice Configuration



# Operation

## Modes Explained

There are two modes of operation in the Element/Element XP: Play Mode and Edit Mode.

### Play Mode

When the Element/Element XP is powered on, the unit will be in Play Mode. Play Mode is indicated by the effect LEDs being lit for the effects which are active in the currently loaded preset and the currently loaded preset number being displayed in the LED display. Play Mode is the normal operating mode and allows you to navigate presets using the **SELECT** knob or **FOOTSWITCHES**.

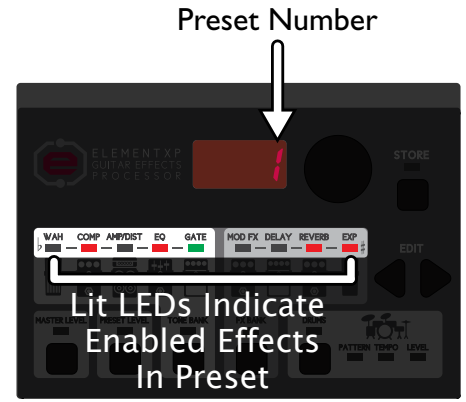

### Edit Mode

You enter Edit Mode whenever you press the **MASTER LEVEL**, **PRESET LEVEL**, **TONE BANK**, **FX BANK**, **DRUMS**, or **EDIT** buttons. Edit Mode allows you to adjust the global Master Level, the Preset Level, select between the different Tone and FX Banks, edit effect and system settings, and edit the settings for the built-in drums. To exit Edit Mode and return to Play Mode, simply press either **FOOTSWITCH**. You can tell you are back in Play Mode when the effect LEDs are lit for the effects which are active in the currently loaded preset and the currently loaded preset number is displayed in the LED display.

**NOTE:** Effect settings changed in Edit Mode will need to be stored to a preset in order to be retained. The exceptions are the Master Level and drum machine settings, which are global settings and are not stored to presets. Whenever you change a stored preset's effect settings, the STORE button LED will light, indicating the effect settings have been changed from the stored value in the preset. See "Storing/Copying Presets" on page 17 for further information on storing presets.



## **Navigating Presets**

There are two banks of presets in the Element/Element XP: the user preset bank and the factory preset bank. From the factory, the user and factory preset banks will contain the same presets. Therefore, factory preset 45 will be the same as user preset 45 and so on. User presets appear in the LED display as *I- 100* and factory presets appear as *F I-F00*. Preset banks will automatically round-robin when navigating. In other words, navigating one preset above user preset *100* will select factory preset *F I* in the factory preset bank. Navigating one preset below user preset *I* will select factory preset *F00* (factory preset 100) in the factory preset bank.

### **To navigate presets:**

- I. From Play Mode, press the **UP FOOTSWITCH** to navigate up through presets or the **DOWN FOOTSWITCH** to navigate down through presets. You can also navigate presets by turning the **SELECT** knob.

## **Editing Presets**

The Element Series processors have been engineered to give you more options for shaping your sounds. Of course you can navigate presets to find sounds which will get you started, and then edit the effects from there to fine tune your sounds—this is standard operation when using effect processors. But there is another layer of options available in the Element processors... Banks. There are two Banks available: Tone Banks and FX Banks. Each of these Banks give you a library of 20 pre-set configurations, allowing you to quickly audition different "tones" without affecting your "effects" chain or vice versa. Using this "coarse" and "fine" editing environment, you can quickly experiment with many different sound-shaping options and go only as deep into editing as you feel comfortable with.

## Selecting A Tone Bank

Tone Banks allow you to select from a preset library of 20 different tones. These tones consist of clean, distortion, and amp tones. Select from a variety of genre-based amp tone defaults ranging from Blues to Metal to Country. Behind the scenes, the Wah (Element XP only), Compressor, Amp/Distortion, EQ, and Noise Gate are configured to create a specified tone. You can then further refine the sound by editing each effect's settings. Note that changing between different Tone Banks does not change the Mod FX, Delay, or Reverb settings, as these processing modules belong to the FX Bank.

### Available Tone Banks

Display Number	Description
1	Overdrive
2	Rock 1
3	Blues 1
4	Metal 1
5	Country 1
6	Warm Drive
7	Crunch
8	Texas Tone
9	Rockabilly
10	Solo 1

### Available Tone Banks

Display Number	Description
11	Fuzz
12	Chunky
13	Smooth
14	Heavy
15	Clean 1
16	British
17	Distortion
18	Scooped
19	Bright Clean
20	Acoustic

### To select a Tone Bank:

1. Press the **TONE BANK** button. The display will read **CU** for custom.
2. Turn the **SELECT** knob to select from one of the 20 Tone Bank library defaults. The number of the selected Tone Bank will appear in the LED display as you turn the **SELECT** knob.
3. When done, press either **FOOTSWITCH** to exit Edit Mode. Note that you must store the changes if you wish to retain the settings. See "Storing/Copying Presets" on page 17 for further information on storing presets.

## Selecting An FX Bank

FX Banks allow you to select from a preset library of 20 different effect chains. Behind the scenes the Mod FX, Delay, and Reverb are configured to create a specified combination of effects. You can then further refine the sound by editing each effect's settings. Note that changing between different FX Banks does not change the Wah (Element XP only), Compressor, Amp/Distortion, EQ, or Noise Gate settings, as these processing modules belong to the Tone Bank.

### Available FX Banks

Display Number	Description
1	Chorus
2	Flanger
3	Phaser
4	Pitch
5	Tremolo
6	Rotary
7	Envelope Filter
8	Digital Delay
9	Analog Delay
10	Tape Delay

### Available FX Banks

Display Number	Description
11	Hall Reverb
12	Spring Reverb
13	Chorus + Digital Delay
14	Chorus + Delay + Reverb
15	Flanger + Analog Delay
16	Phaser + Tape Delay
17	Digital Delay + Hall Reverb
18	Analog Delay + Spring
19	Pitch + Room Reverb
20	Vibrato + Tape Delay

### To select an FX Bank:

1. Press the **FX BANK** button. The display will read **CU** for custom.
2. Turn the **SELECT** knob to select from one of the 20 FX Bank library defaults. The number of the selected FX Bank will appear in the LED display as you turn the **SELECT** knob.
3. When done, press either **FOOTSWITCH** to exit Edit Mode. Note that you must store the changes if you wish to retain the settings. See "Storing/Copying Presets" on page 17 for further information on storing presets.

## Editing Effects

Selecting a preset and/or Tone/FX Bank is the fastest and easiest way to achieve the sound your after. However, if you just can't seem to quite get the sound you're after it's time to edit some effects.

### To edit effects:

1. Press either of the **EDIT** buttons repeatedly until the LED for the effect you wish to edit is lit. For a list of effect settings, see "The Effects" on page 25.
2. Once you have selected the effect for editing, strum your guitar then turn the **SELECT** knob to change the effect settings. Repeat this auditioning process until you find the desired setting.
3. To exit Edit Mode, press either **FOOTSWITCH**.

**NOTE:** Effects changed in Edit Mode will need to be stored to a preset in order to be retained. The exceptions are the Master Level and drum machine settings, which are global settings and are not stored to memory. See "Storing/Copying Presets" on page 17 for further information on storing presets.

## Turning Effects On & Off

The procedure for turning effects on and off is essentially the same as for editing effects.

### To turn an effect on or off:

1. Press either of the **EDIT** buttons repeatedly until the LED for the effect you wish to turn on or off is lit.
2. Turn the **SELECT** knob. If the effect is already turned off, turn the **SELECT** knob to the right to enable the effect and select between the available options. If the effect is already on and you wish to turn it off, keep turning the **SELECT** knob to the left until **OFF** is shown in the LED display.
3. When done, press either **FOOTSWITCH** to return to Play Mode, indicated by the currently loaded preset number being displayed in the LED display.

**NOTE:** Parameters changed in Edit Mode will need to be stored to a preset in order to be retained. The exceptions are the Master Level and drum machine parameters, which are global parameters and are not stored to memory. See "Storing/Copying Presets" on page 17 for further information on storing presets.

## **Storing/Copying Presets**

The STORE button is used to save modifications made to a preset's settings. The STORE button's LED will light whenever effect settings have been changed from their stored value, indicating the changes must be stored to memory to be retained. Preset setting changes must always be stored to a user preset memory location, since factory presets cannot be overwritten. The Element and Element XP have 100 user preset memory locations. Factory presets can be accessed at any time, used as a starting point, edited, then stored to a user preset location. You can also copy a user or factory preset to any of the available 100 user preset locations.

### **To quickly store a preset to its current memory location (quick update):**

1. Make the desired edits to the preset's effect settings. See "Editing Effects" on page 16.
2. Press the **STORE** button twice. **5d** will be briefly displayed in the LED display, indicating the preset is being stored. This will store the newly changed effect settings to the currently loaded preset memory location.

**NOTE:** If you perform the above quick update procedure on a factory preset, the changes will be stored to the equivalent user preset memory location. For example, if you load factory preset 5 (**F 5**), make edits, and then press the **STORE** button twice, you will overwrite user preset 5 (**5**). Therefore, use caution when performing this procedure on factory presets to ensure you do not accidentally overwrite one of your existing user presets.

### **To store an edited preset to a different memory location:**

1. Make the desired edits to the preset's effects. See "Editing Effects" on page 16.
2. Press the **STORE** button once. The current preset number will begin flashing in the LED display.
3. Use the **SELECT** knob to select the user preset memory location at which you would like to store the user preset (indicated in the display).
4. Press the **STORE** button again to complete the store procedure. **5d** will be briefly displayed in the LED display, indicating the preset is being stored.

**NOTE:** Pressing one of the **FOOTSWITCHES** or any button (other than the **DRUMS** button) during the above procedure will abort the store procedure.

### To copy a preset:

1. From Play Mode, use the **FOOTSWITCHES** or **SELECT** knob to load the preset you wish to copy.
2. Press the **STORE** button once. The current preset number will begin flashing in the LED display.
3. Use the **SELECT** knob to select the user preset memory location at which you would like to copy the preset (indicated in the display).
4. Press the **STORE** button again to complete the copy procedure. *5d* will be briefly displayed in the LED display, indicating the preset is being stored.

**NOTE:** Pressing one of the **FOOTSWITCHES** or any button (other than the **DRUMS** button) during the above procedure will abort the store procedure.

## **Bypassing All Effects**

The Element and Element XP offer a global preset bypass feature which bypasses all effects in the currently loaded preset and feeds only the dry/unprocessed signal to the outputs.

### To bypass all effects:

1. Press both **FOOTSWITCHES** simultaneously. The LED display will read *bYP*, indicating the effects are bypassed.
2. Press either **FOOTSWITCH** to exit the preset bypass function.

## **Using The Drum Machine**

Playing along with the built-in drum machine is a great way to improve your timing skills. The Element and Element XP give you 45 drum and metronome patterns to choose from and allow you to adjust the tempo and level of the pattern playback.

### Available Drum Machine Parameters

<b>LED Lit</b>	<b>Option (Shown In Display)</b>	<b>Description</b>
PATTERN	1-45	Selects from the various drum patterns
TEMPO	1-99	Adjusts the drum machine tempo
LEVEL	1-99	Adjusts the drum machine level

### Available Drum Patterns

Display Number	Description
1	BEATS 1
2	BEATS 2
3	BEATS 3
4	BEATS 4
5	BEATS 5
6	BEATS 6
7	ROCK 1
8	ROCK 2
9	ROCK 3
10	ROCK 4
11	ROCK 5
12	ROCK 6
13	HARD ROCK 1
14	HARD ROCK 2
15	HARD ROCK 3
16	HARD ROCK 4
17	METAL 1
18	METAL 2
19	METAL 3
20	METAL 4
21	METAL 5
22	BLUES 1
23	BLUES 2

### Available Drum Patterns

Display Number	Description
24	BLUES 3
25	BLUES 4
26	GROOVE 1
27	GROOVE 2
28	COUNTRY 1
29	COUNTRY 2
30	COUNTRY 3
31	JAZZ 1
32	JAZZ 2
33	JAZZ 3
34	JAZZ 4
35	HIPHOP 1
36	HIPHOP 2
37	HIPHOP 3
38	WORLD 1
39	WORLD 2
40	WORLD 3
41	METRONOME 4/4
42	METRONOME 3/4
43	METRONOME 5/8
44	METRONOME 7/8
45	METRONOME

### To use the built-in drum machine:

1. Press the **DRUMS** button to turn the drum machine on.
2. Use the **EDIT** buttons to select the drum setting you want to edit (i.e., Pattern, Tempo or Level). The corresponding LED will light when a selection is made.
3. Turn the **SELECT** knob to edit the selected setting.
4. Repeat steps 2-3 to make edits to any of the other drum machine settings.
5. When not using the drum machine, press the **DRUMS** button to turn the drum machine off.

**NOTE:** Drum machine settings are global and are not stored to presets.

## Using The Tuner

The built-in tuner allows you to effortlessly tune your guitar and offers 4 different tuning references as shown in the table to the right. In most cases you will use the standard tuning reference, which is A440 (A=440Hz). This is the default tuning reference setting in the Element/Element XP.

The tuner can be accessed from either Play Mode or Edit Mode. As a note is played, the LED display will show the note. The most center effect LED (green) will light when the note is in tune. If an effect LED to the left of the green LED is lit, the note is flat, so you must tune the string up. If an LED to the right of the green LED is lit, the note is sharp, so you must tune the string down.

### Tuning Reference Options

Option (Shown In Display)	Reference
40	A=440Hz (Default, standard setting)
A $\flat$	A=A $\flat$ (A flat)
G	A=G
G $\flat$	A=G $\flat$ (G flat)

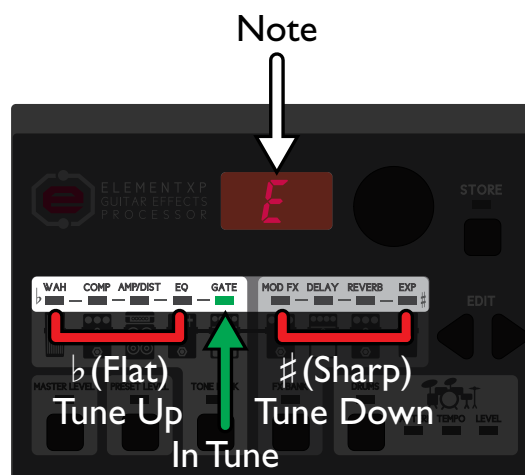

### To use the tuner:

1. Press and hold both **FOOTSWITCHES** simultaneously. The display will read  $b4P$  briefly then  $E4$  then ---. The tuner is now active.
2. If you wish to change the tuning reference, turn the **SELECT** knob. The default tuning reference is A=440Hz (represented as 40 in the LED display), which is considered to be the standard tuning reference and will be used in most cases.
3. Tune your guitar.
4. Press either **FOOTSWITCH** to exit the tuner.

**NOTE:** If preset modifications had been made prior to entering the tuner, the changes will still be available and can be stored after exiting the tuner.



## **Mono/Stereo Operation**

Mono/stereo operation, for both the Main Output and Headphone Output, is determined by whether or not a plug is connected to the 1/4" Main Output jack. If a plug is connected to this jack, all outputs are automatically configured for mono operation, just plug in your amp and play. If no plug is connected to the 1/4" Main Output jack, the outputs default to stereo operation for headphone use. The 1/4" Main Output can be forced to operate in stereo when you need to connect the Main Output to a stereo destination, such as a pair of amplifiers, a mixer, or a recording device.

### **To configure the 1/4" Main Output for stereo operation:**

1. Start with the power cable disconnected (unit powered down).
2. Press and hold the **FX BANK** button while connecting the power cable. Keep the **FX BANK** button held down until the display reads *STEREO On*, then release the button. The 1/4" Main Output is now configured for stereo (TRS) operation.
3. To configure the 1/4" Main Output back to mono operation, follow the same steps above and wait for the display to read *STEREO OFF*.

## **Speaker Cabinet Compensation (SCC)**

The Element Series processors are designed to allow you to play your guitar even if you don't have an amplifier. The built-in Speaker Cabinet Compensation (SCC) feature is what makes this possible. If you've ever listened to a direct guitar signal (using no guitar amplifier) then you know how thin and unnatural it can sound. SCC emulates the frequency response of a guitar speaker cabinet, providing the much more pleasant tone which a guitar cabinet reproduces. Use SCC when connecting to headphones, directly to a mixer, or directly to a recording device.

SCC is automatically enabled when only headphones are connected to the Headphone Output (and no cable is connected to the 1/4" Main Output). If a cable is connected to the Main Output, SCC is defeated, both in the Headphone Output and Main Output. You must enable the SCC feature on the Main Output manually if you wish to connect directly to a recording interface or mixer.

### **To enable Speaker Cabinet Compensation on the Main Output:**

1. Disconnect the power cord from the Element/Element XP processor (unit powered off).
2. Press and hold the **TONE BANK** button while connecting the power cord. Keep the **TONE BANK** button held down until the display reads *CAB INET On*, then release the button.

Speaker Cabinet Compensation is now enabled on all outputs.

**NOTE:** Once enabled, SCC will remain active only while the unit is powered on. After a power cycle, the SCC enabling procedure must be performed again if you want SCC to be enabled.

## **Expression Pedal Calibration (Element XP Only)**

The Expression Pedal on the Element XP comes pre-calibrated from the factory. However, in the event the Expression Pedal does not function properly, it can be re-calibrated using the below Pedal Calibration procedure.

### **To calibrate the Element XP Expression Pedal:**

1. Press and hold both **FOOTSWITCHES** simultaneously until **PE** appears in the LED display. All effects and button LEDs will be turned off.
2. When **Edn** appears in the display, rock the **EXPRESSION PEDAL** forward (toe down) then press either **FOOTSWITCH**.
3. When **EuP** appears in the display, rock the **EXPRESSION PEDAL** back (toe up) then press either **FOOTSWITCH**.
4. If the calibration procedure is successful, the Element XP will return to Play Mode and will be ready for use. If the calibration procedure fails, **Err** will appear in the LED display followed by **Edn**. If this happens, repeat steps 2 and 3 until calibration is successful.

## **Expression Pedal Assignment (Element XP Only)**

The Expression Pedal on the Element XP can be assigned to control the Volume, Wah, Whammy™, YaYa™, or one of several other effects with your foot. You can also assign Minimum (pedal toe up) and Maximum (pedal toe down) values. These Min and Max values will set the range in which the Expression Pedal is allowed to control the assigned effect. The following table shows the effect controls available for Expression Pedal control.

### ***Effects Assignable For Control (Element XP Only)***

<b>Option (Shown In Display)</b>	<b>Effect Controlled (LED Lit)</b>	<b>Description</b>
<i>OFF</i>	–	No assignment (Expression Pedal off)
<i>PrE</i>	PRESET LEVEL	Pre-Delay Output Level (level is adjusted before the Delay effect—delay levels will not be affected by level change and will decay naturally)
<i>PO5</i>	PRESET LEVEL	Post-Delay Output Level (level is adjusted after the Delay effect—delay levels will be affected by level change)
<i>WH</i>	WAH	Expression Pedal acts as a Wah pedal
<i>GA</i>	AMP/DISTORTION	Amp Gain
<i>SP</i>	MOD FX	Chorus Speed
<i>LE</i>	MOD FX	Chorus Level
<i>SP</i>	MOD FX	Flanger Speed
<i>LE</i>	MOD FX	Flanger Level
<i>SP</i>	MOD FX	Phaser Speed
<i>LE</i>	MOD FX	Phaser Level
<i>SP</i>	MOD FX	Tremolo Speed
<i>dEP</i>	MOD FX	Tremolo Depth
<i>SP</i>	MOD FX	Panner Speed
<i>dEP</i>	MOD FX	Panner Depth
<i>SP</i>	MOD FX	Vibrato Speed
<i>dEP</i>	MOD FX	Vibrato Depth
<i>SP</i>	MOD FX	Rotary Speed
<i>dEP</i>	MOD FX	Rotary Depth
<i>PEd</i>	MOD FX	Expression Pedal acts as a YaYa effect
<i>SP</i>	MOD FX	AutoYa Speed
<i>dEP</i>	MOD FX	AutoYa Depth
<i>EnS</i>	MOD FX	Envelope Filter Sensitivity
<i>LE</i>	MOD FX	Detune Level
<i>LE</i>	MOD FX	Pitch Shift Level
<i>WHY</i>	MOD FX	Expression Pedal acts as a Whammy pedal
<i>dEL</i>	DELAY	Delay Level
<i>dEF</i>	DELAY	Delay Feedback
<i>rEL</i>	REVERB	Reverb Level

To assign an effect to the Expression Pedal for control and set the Min/Max values:

1. Any effect you wish to assign to the Expression Pedal must be turned on before it can be assigned. For information on turning an effect on, see "Turning Effects On & Off" on page 16.
2. From Play Mode, press the right arrow **EDIT** button repeatedly until the EXP (Expression) LED is lit. An effect LED will also light indicating which effect the Expression Pedal is currently assigned to and the LED display will show which effect control the Expression Pedal is currently assigned to.
3. Turn the **SELECT** knob to select the effect control you wish to control (see the table on the previous page for a list of effects selectable for control). As you turn the **SELECT** knob the effect's LED associated with the effect control will light.
4. Once you've selected the effect you want to control, press the right arrow **EDIT** button once. You have now selected the Minimum (pedal toe up) control range. Turn the **SELECT** knob to set this to the value which you want the Expression Pedal's full toe up position to represent (the lowest value selectable by the Expression Pedal).
5. Press the right arrow **EDIT** button once. You have now selected the Maximum (pedal toe down) control range. Turn the **SELECT** knob to set this to the value which you want the Expression Pedal's full toe down position to represent (the highest value selectable by the Expression Pedal).
6. Store the changes to a preset for later recall. See "Storing/Copying Presets" on page 17 for further information.

# The Effects

The Element XP offers 37 different effects with the ability to run 9 effects simultaneously. The Element offers 31 different effects with the ability to run 8 effects simultaneously. Both provide 12 amp/cabinet models to choose from. The following section describes each of these available effects and amp/cabinet models.

## **Wah (Element XP Only)**

Wah is an effect controlled by the Expression Pedal and makes the guitar sound as if it's saying "Wah." There are three different wah types to choose from in the Element XP as shown in the below table.

### *Available Wah Options*

<b>Option (Shown In Display)</b>	<b>Description</b>
OFF	Wah effect is turned off
CRY	Dunlop® Cry Baby™ Wah
CLY	Vox® Clyde McCoy™ Wah
FULL	Full Range Wah

## **Compressor**

A compressor is used to compress the dynamic range of a signal (make the loud signals quieter and quiet signals louder). In the Element/Element XP processors, the Compressor is used to add sustain and tighten up the dynamics of the guitar. The Compressor can be adjusted between 1-20 or turned off, as shown in the below table. Lower values represent lighter compression and higher values represent heavier compression (and more sustain). The Compressor's threshold and gain settings are controlled simultaneously when adjusting the Compressor value, making it faster and easier to set. The Compressor's ratio is fixed at infinity:1.

### *Available Compressor Options*

<b>Option (Shown In Display)</b>	<b>Description</b>
OFF	Compressor is turned off
1-20	Higher values increase compression amount and sustain

## **Amp/Distortion Models**

The Element/Element XP have 6 Distortion and 12 Amp/Cabinet models to choose from. Each Amp/Distortion option is identified by a pair of letters (e.g., **Ed**) and has nine settings (i.e., **1-9**), except the Acoustic Guitar Simulator which has only one setting. As the value of the number is increased, the Amp/Distortion gain increases (the signal becomes more distorted). Each Amp Model has a Cabinet Model assigned to it as shown in the following table.

### **Available Amp/Distortion Options**

<b>Option (Shown In Display)</b>	<b>Type</b>	<b>Amp/Distortion Model Description</b>	<b>Cabinet Model Description</b>
<b>OFF</b>	-	Effect turned off	-
<b>Ed 1-9</b>	Amp/Cabinet	'57 Fender® Tweed Deluxe®	Fender Tweed Deluxe 1x12
<b>bF 1-9</b>	Amp/Cabinet	'65 Fender Blackface Twin Reverb®	Fender Twin Reverb 2x12
<b>PL 1-9</b>	Amp/Cabinet	'68 Marshall® Super Lead (Plexi)	Marshall Slant Celestion® Greenback 4x12
<b>bS 1-9</b>	Amp/Cabinet	'77 Marshall Master Volume	Marshall Straight Celestion G12-T70 4x12
<b>uL 1-9</b>	Amp/Cabinet	'83 Marshall JCM800	Marshall Straight Celestion G12-T70 4x12
<b>RC 1-9</b>	Amp/Cabinet	'63 Vox® AC30 Top Boost	AC30 TB Jensen® Blue Back 2x12
<b>rE- 1-9</b>	Amp/Cabinet	'01 Mesa/Boogie® Dual Rectifier™	Johnson® Straight Celestion Vintage 30 4x12
<b>EH 1-9</b>	Amp/Cabinet	'96 Matchless® DC-30	Johnson Straight Celestion Vintage 30 4x12
<b>SO 1-9</b>	Amp/Cabinet	DigiTech® Solo	DigiTech Solo 4x12
<b>Ee 1-9</b>	Amp/Cabinet	DigiTech Metal	DigiTech Metal 4x12
<b>EL 1-9</b>	Amp/Cabinet	DigiTech Bright Clean	DigiTech Bright Clean 2x12
<b>Et 1-9</b>	Amp/Cabinet	DigiTech Clean Tube	Fender Twin Reverb 2x12
<b>ES 1-9</b>	Distortion	Ibanez® TS-9 Tube Screamer™	-
<b>od 1-9</b>	Distortion	DOD® 250 Preamp/Overdrive	-
<b>dS 1-9</b>	Distortion	Boss® DS-1™ Distortion	-
<b>Gr 1-9</b>	Distortion	DigiTech Grunge®	-
<b>dL 1-9</b>	Distortion	DigiTech Death Metal	-
<b>bP 1-9</b>	Distortion	Electro Harmonix® Big Muff® Pi	-
<b>ACG</b>	Simulator	Acoustic Guitar Simulator	-

## **EQ**

The 3-band EQ lets you further shape the tone of each preset. Each EQ band is identified with a pair of letters (e.g., **bR** represents the bass band) and has nine settings (i.e., 1-9). Settings 1-4 represent EQ cut (1 = 12dB cut, 2 = 9dB cut, 3 = 6dB cut, 4 = 3dB cut). Settings 5-9 represent EQ boost (5 = 3dB boost, 6 = 6dB boost, 7 = 9dB boost, 8 = 12dB boost). A setting of 5 represents no cut or boost (flat). The following table shows the available EQ options.

### *Available EQ Options*

<b>Option (Shown In Display)</b>	<b>Description</b>
<b>bR 1-9</b>	Low frequency (bass) tone control
<b>ld 1-9</b>	Mid frequency (midrange) tone control
<b>tr 1-9</b>	High frequency (treble) tone control

## **Noise Gate**

The Element and Element XP offer two noise gate types: Silencer and AutoSwell.

- **Silencer Gate (noise reduction)**

The Silencer Gate is designed to eliminate noise when you are not playing. The Silencer's nine settings (**GR 1-GR9**) determine the threshold, with 1 being the lowest threshold and 9 being the highest. This determines how loud a signal must be before it can open the gate and be heard. The higher the setting, the louder a signal must be in order to open the gate.

- **AutoSwell Gate (pluck detector gate)**

The AutoSwell Gate creates an automatic volume swell effect. The AutoSwell's nine settings (**SL 1-SL9**) determine the attack time (how quickly the volume swell grows from the note or chord you play). The higher the setting, the slower the swell grows.

### *Available Noise Gate Options*

<b>Option (Shown In Display)</b>	<b>Description</b>
<b>OFF</b>	Noise Gate effect is turned off
<b>GR 1-9</b>	Silencer Gate
<b>SL 1-9</b>	AutoSwell Gate

## **Mod FX**

The Element/Element XP offer a variety of modulation and pitch effect types to choose from. Each modulation effect is identified by a pair of letters (e.g., *PH* for phaser) and has nine settings (i.e., 1-9). These settings include a variety of configurations that generally range from a more subtle effect (lower settings) to a more extreme effect (higher settings). The following table shows the available Mod FX options.

### **Available Mod FX Options**

<b>Option (Shown In Display)</b>	<b>Description</b>
<i>OFF</i>	Mod FX is turned off
<i>CH 1-9</i>	Modeled after a Boss® CE-2 Chorus
<i>dC 1-9</i>	Dual Chorus
<i>FL 1-9</i>	Flanger
<i>PH 1-9</i>	Phaser
<i>Tr 1-9</i>	Tremolo
<i>PA 1-9</i>	Panner
<i>br 1-9</i>	Vibrato
<i>ro 1-9</i>	Rotary
<i>YA 1-9</i>	YaYa® (Element XP only)
<i>AY 1-9</i>	AutoYa®
<i>SF 1-9</i>	Step Filter
<i>EF 1-9</i>	Envelope Filter
<i>dt 1-9</i>	Detune
<i>Sh 1-9</i>	Pitch Shift
<i>HA 1-9</i>	Whammy (Element XP only)

The following section describes each of the available modulation and pitch effect types available in the Element/Element XP.

- **Chorus**

The chorus effect adds a short delay to your signal. The delayed signal is modulated in and out of tune and then mixed back with the original signal to create a thicker, more lush sound which has movement and depth.

- **Flanger**

The flanger effect uses the same principles as the chorus effect, but uses a shorter delay time and adds regeneration (or repeats) to the modulating delay. This results in an exaggerated up and down sweeping motion of the effect.

- **Phaser**

The phaser effect splits the incoming signal then changes the phasing of the signal. This signal is then taken in and out of phase and mixed back in with the original signal. As the phasing changes, different frequencies get canceled resulting in a warm sort of twisting sound.



- **Tremolo**  
The tremolo effect modulates the volume of the signal at an even rate.
- **Panner**  
The panner effect modulates the sound from left to right at an even rate.
- **Vibrato**  
The vibrato effect modulates the pitch of the incoming signal at an even rate.
- **Rotary Speaker**  
The rotary speaker effect is an emulation of a classic Leslie amplifier/speaker which included a spinning horn and woofer or sound-directing duct. The rotation of these two speakers or duct produces an interesting combination of the sound panning from side to side. This produces a slight pitch change due to the speed of the sound coming towards, and then going away from the listener. This is the same effect you experience when a moving car or train passes you, the pitch increases as the car or train approaches then decreased as it travels away. This phenomenon is referred to as the Doppler effect.
- **YaYa™ (Element XP Only)**  
The YaYa effect combines the characteristics of a wah and a flanger, creating an almost human vowel characteristic, as if the guitar were saying "Yah." This effect is controlled using the Expression Pedal.
- **AutoYa™**  
Similar to the YaYa effect described above, the AutoYa effect automatically modulates the sound at an even rate, so Expression Pedal control is not required.
- **Step Filter**  
The step filter effect is like an automatic "random wah" with a square waveform.
- **Envelope Filter**  
The envelope filter is a dynamic wah effect that alters your sound based upon how hard you play.
- **Detune**  
The detune effect makes a copy of your incoming signal, makes the copied signal slightly out of tune from the original, then mixes the two signals together. The result is a doubling type of effect as if two guitars were playing the same part together, but slightly out of tune with one another.
- **Pitch Shift**  
The pitch shift effect copies the incoming signal, then shifts the pitch of the copy to a different note. The shifted note is then mixed back with the original signal, sounding as if two guitars were playing together, but playing different notes.
- **Whammy™ (Element XP Only)**  
The Whammy effect is a variable pitch shifter. This effect is basically a pitch shifter, but allows you to vary the amount of pitch shifting with the Expression Pedal, creating a sweepable pitch shifting effect.

## **Delay**

Delay is an effect that records the incoming signal then plays it back a short time later. The recorded signal can repeat just once or several times, depending upon the type of delay. The Element and Element XP offer 4 different delay types: Analog Delay, Digital Delay, Ping Pong Delay, and Tape Delay. Each of these delay types have 5 seconds of delay time available, with the exception of the Analog Delay which has up to 350ms.

There are two different effect settings used to program the Delay effect in the Element/Element XP: Delay Type and Delay Time. The Delay Type setting selects the delay type and varies the amount of feedback (number of repeats) and level as shown in the following table.

### ***Available Delay Type Options***

<b>Option (Shown In Display)</b>	<b>Delay Type</b>	<b>Variation Description</b>
<b>OFF</b>	-	Delay effect is turned off
<b>A01</b>	Analog Delay	feedback=5%, level=15
<b>A02</b>	Analog Delay	feedback=5%, level=30
<b>A03</b>	Analog Delay	feedback=5%, level=50
<b>A04</b>	Analog Delay	feedback=20%, level=15
<b>A05</b>	Analog Delay	feedback=20%, level=30
<b>A06</b>	Analog Delay	feedback=20%, level=50
<b>A07</b>	Analog Delay	feedback=45%, level=15
<b>A08</b>	Analog Delay	feedback=45%, level=30
<b>A09</b>	Analog Delay	feedback=45%, level=50
<b>DD1</b>	Digital Delay	feedback=5%, level=15
<b>DD2</b>	Digital Delay	feedback=5%, level=30
<b>DD3</b>	Digital Delay	feedback=5%, level=50
<b>DD4</b>	Digital Delay	feedback=20%, level=15
<b>DD5</b>	Digital Delay	feedback=20%, level=30
<b>DD6</b>	Digital Delay	feedback=20%, level=50
<b>DD7</b>	Digital Delay	feedback=45%, level=15
<b>DD8</b>	Digital Delay	feedback=45%, level=30
<b>DD9</b>	Digital Delay	feedback=45%, level=50

### ***Available Delay Type Options***

<b>Option (Shown In Display)</b>	<b>Delay Type</b>	<b>Variation Description</b>
<b>PP1</b>	Ping Pong Delay	feedback=5%, level=15
<b>PP2</b>	Ping Pong Delay	feedback=5%, level=30
<b>PP3</b>	Ping Pong Delay	feedback=5%, level=50
<b>PP4</b>	Ping Pong Delay	feedback=20%, level=15
<b>PP5</b>	Ping Pong Delay	feedback=20%, level=30
<b>PP6</b>	Ping Pong Delay	feedback=20%, level=50
<b>PP7</b>	Ping Pong Delay	feedback=45%, level=15
<b>PP8</b>	Ping Pong Delay	feedback=45%, level=30
<b>PP9</b>	Ping Pong Delay	feedback=45%, level=50
<b>TA1</b>	Tape Delay	feedback=5%, level=15
<b>TA2</b>	Tape Delay	feedback=5%, level=30
<b>TA3</b>	Tape Delay	feedback=5%, level=50
<b>TA4</b>	Tape Delay	feedback=20%, level=15
<b>TA5</b>	Tape Delay	feedback=20%, level=30
<b>TA6</b>	Tape Delay	feedback=20%, level=50
<b>TA7</b>	Tape Delay	feedback=45%, level=15
<b>TA8</b>	Tape Delay	feedback=45%, level=30
<b>TA9</b>	Tape Delay	feedback=45%, level=50

The second delay setting is Delay Time. Delay Time is indicated in the LED display by a value between 10-990 (10ms-990ms) or 1 0-5 0 (1.0-5.0 seconds respectively in 100ms (0.1 second) increments), as shown in the table below. As previously mentioned, the Analog Delay is the exception and provides up to 350ms of delay time.

### Available Delay Time Options

Option (Shown In Display)	Description
1-35 (Analog Delay)	10ms-350ms in 10ms increments (Analog Delay)
1-99	10ms-990ms in 10ms increments
1 0-5 0	1-5 seconds in 100ms (0.1 sec) increments

## Reverb

Reverb can be used for live performance or recording. When recording straight from the output of the Element/Element XP, the room reverb can be used to add a sense of space, so that the recorded guitar sounds more like a mic'd up guitar cabinet in a room. The Element/Element XP have three different reverb types to choose from, each with 9 varying levels (1-9); the higher the value, the higher the level of the reverb effect.

### Available Reverb Options

Option (Shown In Display)	Name	Description
OFF	-	Reverb effect is turned off
SP 1-9	Spring	A classic yet popular effect for guitar players, this spring reverb is modeled after the spring reverb found in a Fender® Twin Reverb® amplifier and can be used to add a retro vibe to your guitar sound.
RM 1-9	Room	This reverb reproduces the sound of a small to medium sized room. Use this reverb when you want to create a sense of space without the guitar sounding too distant. This reverb works well with up-tempo riffs.
HL 1-9	Hall	This reverb simulates a large concert hall. Use this reverb with slower riffs when you really want to create a large, lush, open space.

# Element Preset List

User	Factory	Name
1	F 1	Rectified
2	F 2	Tough Echo
3	F 3	Clean Detune
4	F 4	Fuzz Pie
5	F 5	Roadhouse
6	F 6	Oh My 80s
7	F 7	Comp Clean
8	F 8	Big Plexi
9	F 9	Flange Beast
10	F 10	Phase Rock
11	F 11	Super Comp
12	F 12	Pompadour
13	F 13	Mighty Distortion
14	F 14	Clean Chorus/Delay
15	F 15	British Stack
16	F 16	Super Tweed
17	F 17	Crunch Delay
18	F 18	Funky Envelope
19	F 19	Metal March
20	F 20	Dark 'n Dirty
21	F 21	High Gain Solo
22	F 22	Screamin' OD
23	F 23	Top Boost Combo
24	F 24	Rockin'
25	F 25	Boogie Woogie
26	F 26	Roto Grind
27	F 27	Goose Grease
28	F 28	OctavePus
29	F 29	Tube Delay
30	F 30	Knife's Edge
31	F 31	Unplugged
32	F 32	Megaton
33	F 33	OctaFuzz
34	F 34	Meditation

User	Factory	Name
35	F 35	Big Comfort
36	F 36	Stacked
37	F 37	Take the 5th
38	F 38	Retro Phase/Delay
39	F 39	Jazz Box
40	F 40	7 Avenged
41	F 41	Almighty Twin
42	F 42	Smoothy
43	F 43	Dog Hair
44	F 44	Step NTime
45	F 45	The Edge
46	F 46	How Soon Is Now
47	F 47	Grotto
48	F 48	Lotta Love
49	F 49	Kill Switch
50	F 50	Stone Ages
51	F 51	Classic Solo
52	F 52	Follow Me
53	F 53	Sub Mosh
54	F 54	Warm Drive
55	F 55	Gain Green
56	F 56	Deep Trem
57	F 57	Bluegrass
58	F 58	Sustainer
59	F 59	Vintage Chorus
60	F 60	Cool Rhythm
61	F 61	MrVibe
62	F 62	Gritty Kitty
63	F 63	Big Punch
64	F 64	Hole in My Life
65	F 65	Amp Screamer
66	F 66	Gilmouresque
67	F 67	El Surf
68	F 68	Acoustic Pong

User	Factory	Name
69	F 69	Funky Flange
70	F 70	Guitar Organ
71	F 71	Ultra Detune/Delay
72	F 72	Lenny Flange
73	F 73	Lo Fi
74	F 74	Soft Attack
75	F 75	Purple Smog
76	F 76	Echo Man
77	F 77	Smiley EQ
78	F 78	Vibro Wash
79	F 79	Run Like Hell
80	F 80	King Buzzo
81	F 81	Thicken It
82	F 82	Punchy
83	F 83	Legato Solo
84	F 84	Lonely Heart
85	F 85	Snake Flange
86	F 86	Over Drive
87	F 87	The Triplets
88	F 88	Bounceback
89	F 89	Touch Fuzz
90	F 90	Big Bite
91	F 91	Jangle
92	F 92	Forever 4ths
93	F 93	Black In Back
94	F 94	Bigfoot
95	F 95	Bluesman
96	F 96	Another Phase
97	F 97	Trem/Delay
98	F 98	Mosquito
99	F 99	Voxy Clean
100	F 00	Per-Plexied

# Element XP Preset List

User	Factory	Name
1	F 1	Rectified
2	F 2	Tough Echo
3	F 3	Clean Detune
4	F 4	Fuzz Pie
5	F 5	Roadhouse
6	F 6	Oh My 80s
7	F 7	Comp Clean
8	F 8	Big Plexi
9	F 9	Flange Beast
10	F 10	Phase Rock
11	F 11	Super Comp
12	F 12	Pompadour
13	F 13	Mighty Distortion
14	F 14	Clean Chorus/Delay
15	F 15	British Stack
16	F 16	Super Tweed
17	F 17	Crunch Delay
18	F 18	Funky Envelope
19	F 19	Whammy Up
20	F 20	Dark 'n Dirty
21	F 21	High Gain Solo
22	F 22	Screamin' OD
23	F 23	Top Boost Combo
24	F 24	Power Wah
25	F 25	Boogie Woogie
26	F 26	Roto Grind
27	F 27	Goose Grease
28	F 28	OctavePus
29	F 29	Tube Delay
30	F 30	Knife's Edge
31	F 31	Unplugged
32	F 32	Megaton
33	F 33	OctaFuzz
34	F 34	Meditation

User	Factory	Name
35	F 35	Big Comfort
36	F 36	Stacked
37	F 37	Take the 5th
38	F 38	Retro Phase/Delay
39	F 39	Jazz Box
40	F 40	7 Avenged
41	F 41	Almighty Twin
42	F 42	Smoothy
43	F 43	Dog Hair
44	F 44	Step NTime
45	F 45	The Edge
46	F 46	How Soon Is Now
47	F 47	Grotto
48	F 48	Lotta Love
49	F 49	Kill Switch
50	F 50	Stone Ages
51	F 51	Classic Solo
52	F 52	Follow Me
53	F 53	Sub Mosh
54	F 54	Warm Drive
55	F 55	Gain Green
56	F 56	Deep Trem
57	F 57	Bluegrass
58	F 58	Sustainer
59	F 59	Vintage Chorus
60	F 60	Cool Rhythm
61	F 61	MrVibe
62	F 62	Wah Crunch
63	F 63	Big Punch
64	F 64	Hole in My Life
65	F 65	Amp Screamer
66	F 66	Gilmouresque
67	F 67	El Surf
68	F 68	Acoustic Pong

User	Factory	Name
69	F 69	Funky Flange
70	F 70	Guitar Organ
71	F 71	Ultra Detune/Delay
72	F 72	Lenny Flange
73	F 73	Lo Fi
74	F 74	Soft Attack
75	F 75	Purple Smog
76	F 76	Echo Man
77	F 77	Smiley EQ
78	F 78	Vibro Wash
79	F 79	Run Like Hell
80	F 80	King Buzzo
81	F 81	Thicken It
82	F 82	Punchy
83	F 83	Legato Solo
84	F 84	Lonely Heart
85	F 85	Snake Flange
86	F 86	Over Drive
87	F 87	The Triplets
88	F 88	Bounceback
89	F 89	Touch Fuzz
90	F 90	Big Bite
91	F 91	Jangle
92	F 92	Forever 4ths
93	F 93	Black In Back
94	F 94	Bigfoot
95	F 95	Bluesman
96	F 96	Another Phase
97	F 97	Trem/Delay
98	F 98	Mosquito
99	F 99	Voxy Clean
100	F 00	Per-Plexied

# Technical Information

## **Factory Restore**

The Factory Restore procedure will return the Element/Element XP to its factory default state.

**WARNING!** The Factory Restore procedure will reset all modified user presets and return them to their factory default settings. This procedure is permanent and cannot be undone.

### **To perform the Factory Restore procedure:**

1. Start with the power cable disconnected (unit powered down).
2. Press and hold the **STORE** button while connecting the power cable. When *Fr* appears in the display, release the **STORE** button then quickly press and hold the **STORE** button again for 3 seconds until *r5t* appears in the LED display then release.
3. The Factory Restore procedure will be performed. Wait for it to finish. At this point the Factory Restore procedure will be complete if using an Element. When resetting an Element XP, you must proceed to step 4 to calibrate the Expression Pedal.
4. When *Edn* appears in the display (Element XP only), the Element XP's Expression Pedal is ready to be calibrated. Rock the **EXPRESSION PEDAL** forward (toe down) then press either **FOOTSWITCH**.
5. When *EuP* appears in the display, rock the **EXPRESSION PEDAL** back (toe up) then press either **FOOTSWITCH**.
6. If the calibration procedure is successful, the Element XP will return to Play Mode and will be ready for use. If the calibration procedure fails, *Err* will appear in the LED display followed by *Edn*. If this happens, repeat steps 4 and 5 until calibration is successful.

# **Specifications**

## **General Specifications**

A/D/A Converter:	24-bit high performance audio
Sampling Frequency:	44.1 kHz
DSP Section:	AudioDNA2™ DSP Processor
Simultaneous Effects:	8 (Element) 9 (Element XP)
Preset Memory:	100 User Presets (1-100) / 100 Factory Presets (F 1-F00)
Drum Machine:	45 Patterns
Dimensions:	6.25" (L) × 4.5" (W) × 2.25" (H) (Element) 6.25" (L) × 8" (W) × 2.25" (H) (Element XP)
Unit Weight:	0.75 lbs. (Element) 1.20 lbs. (Element XP)

## **Analog Input Connections**

Guitar Input:	1/4" Unbalanced (TS)
Input Impedance:	500k $\Omega$

## **Analog Output Connections**

Left/Right Output:	1/4" Stereo TRS
Left/Right Output Impedance:	500 $\Omega$ per side
Maximum Output:	+7.0 dBu
Headphones:	1/8" Stereo (TRS), 17.4mW per channel @ 50 $\Omega$

## **Power**

Power Consumption:	1.6 Watts (<175 mA @ 9VDC)
Power Requirements:	9VDC External Adapter
Power Adapter:	PS0913DC-01 (US, JA, EU) PS0913DC-02 (AU, UK)

Product specifications are subject to change without notice.

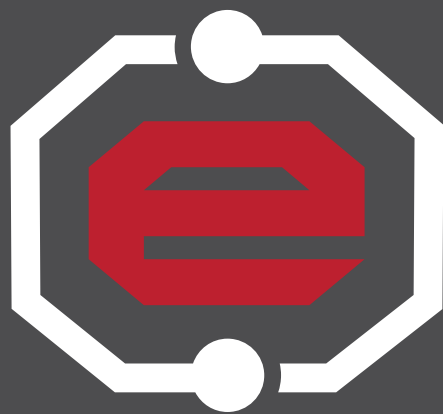

ELEMENT  
GUITAR EFFECT PROCESSORS



8760 South Sandy Parkway  
Sandy, Utah 84070

WEB: [digitech.com](http://digitech.com)  
SUPPORT: [digitech.com/en-US/support](http://digitech.com/en-US/support)

Element / Element XP Owner's Manual 5037184-A

DigiTech is a registered trademark of Harman.

© 2013 Harman. All Rights Reserved.



DigiTech, Johnson Amplification, DOD, Grunge, YaYa, AutoYa, and Whammy are trademarks of Harman in the U.S. and other countries. Dunlop, Cry Baby, Vox, Clyde McCoy, Fender, Tweed Deluxe, Twin Reverb, Marshall, Celestion, Jensen, Mesa/Boogie, Dual Rectifier, Matchless, Ibanez, Tube Screamer, Boss, DS-1, Electro Harmonix, and Big Muff are trademarks of their respective companies in the U.S. and other countries and are not associated or affiliated with DigiTech or Harman.