

ORANGETM

AMPLIFICATION

ROCKER 15/32

OWNER'S MANUAL

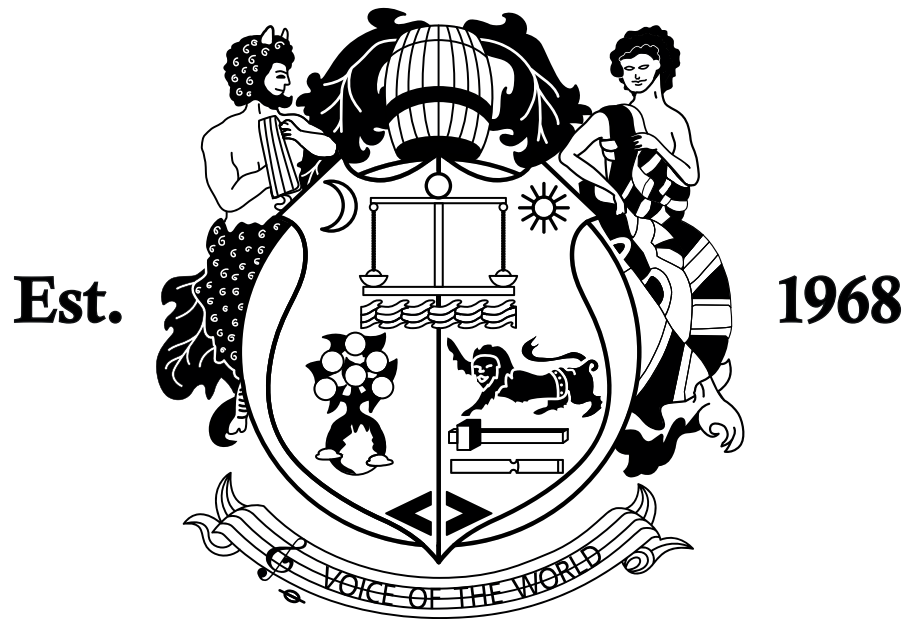

Est.

1968

London | England

DESIGNED AND ENGINEERED BY ORANGE MUSIC ELECTRONIC COMPANY LTD.
108 RIPON WAY, BOREHAMWOOD, WD6 2JA, UK. ORANGEAMPS.COM

IMPORTANT SAFETY INSTRUCTIONS

1. Read these instructions.
2. Keep these instructions.
3. Heed all warnings.
4. Follow all instructions.
5. Do not use this apparatus near water.
6. Clean only with a dry cloth.
7. Do not block any ventilation openings. Install in accordance with the manufacturer's instructions.
8. Do not install near any heat sources such as radiators, heat registers, stoves, or other apparatus (including amplifiers) that produce heat.
9. Do not defeat the safety purpose of the polarised or grounding-type plug. A polarised plug has two blades with one wider than the other. A grounding type plug has two blades and a third grounding prong. The wide blade or the third prong are provided for your safety. If the provided plug does not fit into your outlet, consult an electrician for replacement of the obsolete outlet.
10. Protect the power cord from being walked on or pinched particularly at plugs, convenience receptacles, and the point where they exit from the apparatus.
11. Only use attachments/accessories specified by the manufacturer.
12. Use only with the cart, stand, tripod, bracket, or table specified by the manufacturer, or sold with the apparatus. When a cart is used, use caution when moving the cart/apparatus combination to avoid injury from tip-over.
13. Unplug this apparatus during lightning storms or when unused for long periods of time.
14. Refer all servicing to qualified service personnel. Servicing is required when the apparatus has been damaged in any way, such as power-supply cord or plug is damaged, liquid has been spilled or objects have fallen into the apparatus, the apparatus has been exposed to rain or moisture, does not operate normally, or has been dropped.



The exclamation point within an equilateral triangle and "WARNING" are intended to alert the user to the presence of important operating or servicing instructions. Failure to heed the instructions will result in severe injury or death.

This equipment should be used under the supervision of an adult at all times.



The lightning flash with arrowhead symbol, within an equilateral triangle, is intended to alert the user to the presence of un-insulated 'dangerous voltage' within the product's enclosure that may be of sufficient magnitude to constitute a risk of electric shock to persons. Terminals labelled as "SPEAKER OUTPUTS" must be connected to a speaker cabinet of the designated load (Ω) rating using an un-shielded two conductor cable for speaker use at all times during operation.



The "Caution, hot surface" symbol indicates that the marked item may be hot.

Do not cover or block ventilation openings. Ensure the apparatus is installed with plenty of space around the unit (> 6"/12.5cm) as this apparatus may generate heat under normal use. This equipment is not intended to be used on soft support (like beddings, blankets etc.). This equipment should always be placed on a flat, stable surface.



To reduce the risk of fire and electric shock do not expose this apparatus to rain or moisture. For indoor use only. Do not use in damp environments, e.g. bathrooms etc.



Do not place objects containing liquids on, or near the product.

Do not operate this apparatus or connect/disconnect a power plug whilst hands are wet.



Do not attempt to gain access to the interior of the product. No user serviceable parts inside. Refer all servicing to qualified servicing personnel.



This symbol indicates this product is classified as Waste Electrical and Electronic Equipment (WEEE) in the European Union and should not be discarded with household waste. Contact your local authority for more information and details of your nearest approved disposal facility.

POWERING YOUR UNIT

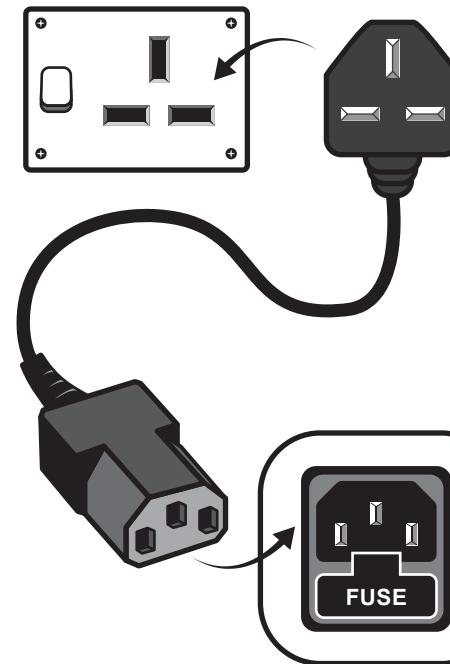

WARNING

Connect the included power cord/plug to an AC mains socket outlet with a protective earthing connection.

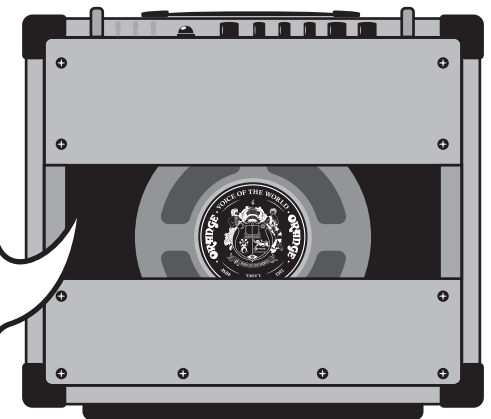

WARNING



FUSE INFORMATION

The mains fuse is provided for your safety. The fuse rating for your model and region is indicated near the unit's AC mains inlet

Do not replace with a fuse of a different type

T = Time Delay ("Slow Blow")

mA or A = Rated current, expressed in mA or A

L = Low breaking capacity or;
H = High breaking capacity

If the mains fuse repeatedly blows, contact your Orange dealer.

DO NOT TAMPER WITH VOLTAGE SELECTOR SWITCH



The voltage selector switch is located on the rear or side of the product. It is set at the factory for the country or region in which the unit is intended to be sold. If the unit is to be used overseas, contact Orange Amplification.

GENERAL USE

- Before switching on the power, set the unit's volume control(s) to minimum.
- Ensure the correct speaker load is connected at all times during operation. Refer to the section entitled "SPEAKER OUTPUTS"
- Use good quality shielded instrument cable to connect your instrument to your unit's input.
- To prevent excessive hum and electrical noise, operate your amplifier and instruments as far away as possible from other electronic devices. Examples include: refrigerators, motors, air conditioners, television sets, radio receivers etc.

START UP PROCEDURE FOR VALVE AMPLIFIERS

Before switching the **POWER** switch to the **ON** position, ensure the **HALF/STBY/FULL** switch is set to the **STBY** (Startup Tension Bypass) mode.

Leave the amp in **STBY** mode for at least 2 minutes prior to performance. This will help prolong the life of the valves [tubes]. After 2 minutes, switch to play mode (**FULL** or **HALF** power). Select the **STBY** mode during breaks in performance.



SELECTING STBY OR PLAY MODE:

OUTPUT (FULL / HALF)

This switch toggles between **FULL** and **HALF** power modes. In **HALF** power mode, the volume will be reduced and output valve overdrive can be achieved at lower output levels. The centre position selects **STBY** mode.

SERVICING INFORMATION FOR VALVE AMPLIFIERS

Periodic valve renewal should be considered part of owning a quality valve [tube] amplifier. The rate of valve wear is dependent on many factors, but if you notice a change in the performance of your amplifier, it is likely a result of valve decline. Valves can fail at any time. Output valves (EL84, EL34, 6550 etc.) are subject to more stress than preamp valves (12AX7, 12AT7 etc.) and may require more regular replacement. Consult your service centre/dealer for more information.

Output valves should always be replaced with matched sets, though not all models require a bias adjustment. Contact your Orange dealer for more information.

Bias adjustment should only be performed by authorised service personnel.

The fuse labelled "**HT FUSE**" will blow in the event of output valve failure. The output valve(s) should be replaced, and the HT fuse replaced with the correct 250V type. The rating is indicated on the product near the HT fuse holder.

Our *Orange Valve Tester* can be used to help match valves and check valve health.

Visit orangeamps.com for more information.

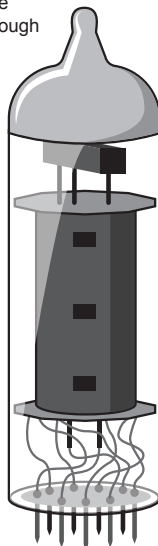

FRONT PANEL

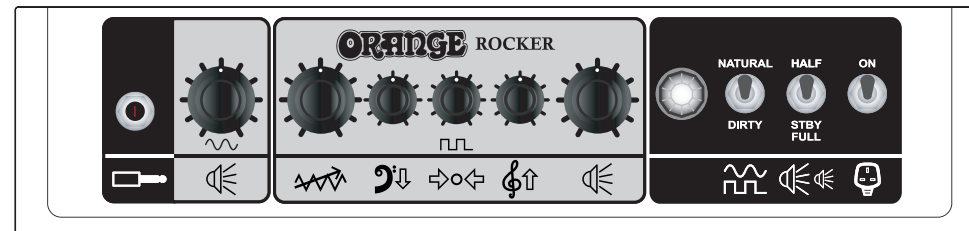

The **Natural Channel** gives the purest route from guitar to speaker with just a single volume control. It has no EQ controls but is voiced to complement your guitar's natural tone. As a 'non-master'-style channel, the output valves will begin to saturate into overdrive at high volume settings.

The **Dirty Channel** can be set clean or distorted by balancing where the gain and volume controls are set. Lower gain settings will produce cleaner tones.

Note: The EQ controls only affect the Dirty Channel.

ORANGE ICONS

- INPUT**
¼" instrument jack socket.
- POWER**
The lamp will illuminate to indicate the power is switched to ON.
Refer to page 4 for the HALF/STBY/FULL switch.
- CHANNEL**
Toggles between the Natural and Dirty channel. This can be switched remotely using an optional footswitch (see rear).
- VOLUME**
Adjusts the volume level for either the Natural or Dirty channel.

DIRTY CHANNEL EQ

- GAIN**
Controls the (preamplifier) gain level. Higher settings produce more distortion. Note: When set to minimum, no sound will be heard.
- BASS**
Adjusts the lower frequency response. Increasing the bass produces deeper sounds.
- MID**
Adjusts the midrange response. Increasing the mids creates a fatter sound, whilst reducing 'scoops' the tone.
- TREBLE**
Adjusts the high frequency response. Increase the treble for brighter tones or reduce for a warmer sound.

REAR ICONS

- FX LOOP**
Used to place external effects between the amplifier's preamplifier section and output section. Connect the SEND jack to the input of external effects. Connect the output of external effects to the RETURN jack.
- FOOT SWITCH**
Connect a latching footswitch (e.g. *Orange FS-1*) to remotely select between Natural and Dirty channels.

ROCKER 15 REAR CONNECTIONS

The HEADROOM/BEDROOM attenuator switch works with the FULL/STBY/HALF switch on the top panel to vary the output power:

- HEADROOM (FULL) = 15 Watts
- HEADROOM (HALF) = 7 Watts
- BEDROOM (FULL) = 1 Watt
- BEDROOM (HALF) = 0.5 Watt

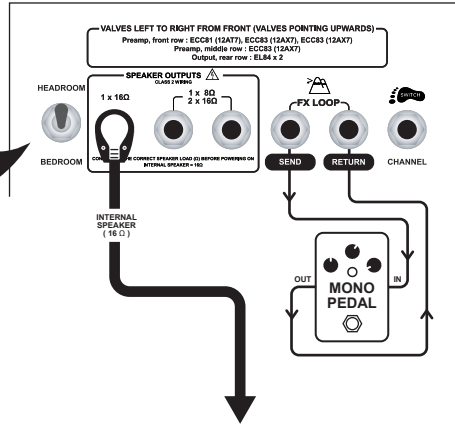

EXTENSION CABINET

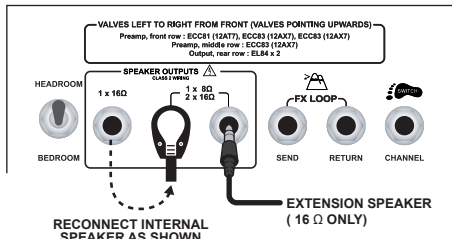

2 x 16Ω CABINETS

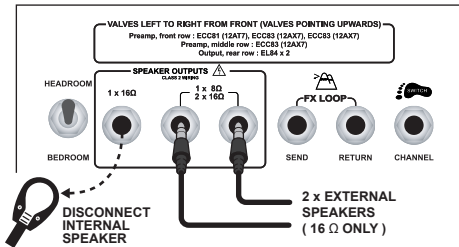

1 x 8Ω CABINET

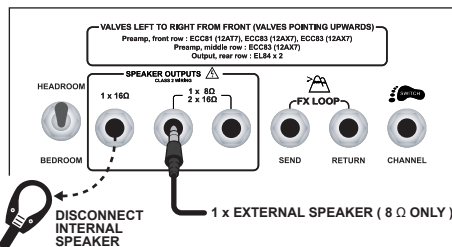

⚠ SPEAKER OUTPUTS ⚡

THE ROCKER 15 MUST BE CONNECTED TO A SPEAKER LOAD (Ω) AT ALL TIMES DURING OPERATION.

NEVER PLUG ANYTHING OTHER THAN A SPEAKER CABLE INTO THE SPEAKER OUTPUT. ONLY CONNECT SPEAKER CABINETS AS SHOWN.

NEVER USE AN INSTRUMENT CABLE TO CONNECT SPEAKERS. ONLY USE UNSHIELDED TWO CONDUCTOR SPEAKER CABLE.

NEVER CONNECT X 2 CABINETS OF DIFFERENT IMPEDANCES (Ω).

ENSURE THE SPEAKER CABINET'S POWER HANDLING RATING (WATTS RMS) IS SUITABLE FOR YOUR AMPLIFIER. IF YOU ARE UNSURE, CONTACT YOUR ORANGE DEALER.

1 x 16Ω CABINET

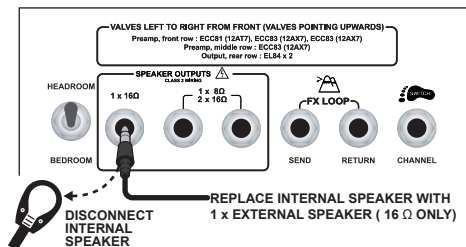

ROCKER 32 REAR CONNECTIONS

MONO

When used in MONO, the effected signal will be heard through both speakers (left & right). In this way, the Rocker 32's effects loop works like a 'normal' amplifier.

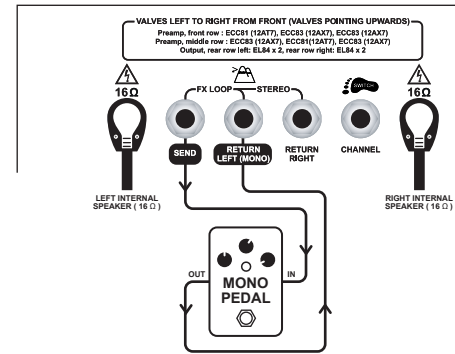

2 SEPARATE MONO FX CHAINS

Note: When **Effects Chain A** is selected, audio will only be heard through the left speaker. When **Effects Chain B** is selected, audio will only be heard through the right speaker. When both **Effects Chains** are selected (Y), audio will be heard through both left and right speakers.

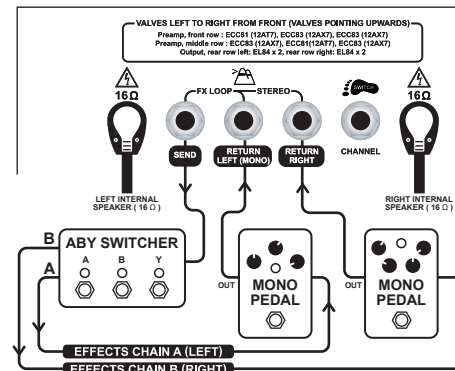

Use a high quality ABY box with isolated outputs such as the *Orange Amp Detonator*.

STEREO

Connect pedals with a stereo output for panning delay effects, spacious reverbs etc.

Note: Some stereo pedals operate in Wet/Dry, where the effected (Wet) signal only appears on the second output (right speaker).

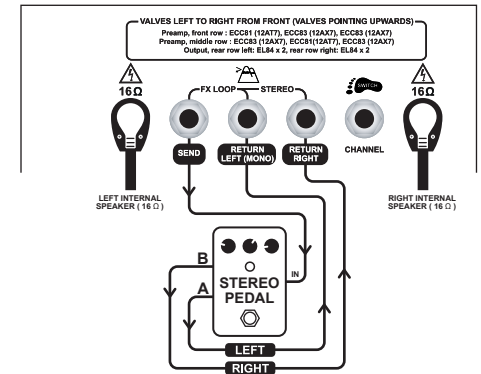

STEREO (WET/DRY)

In this setup the unaffected (Dry) signal is sent to the left speaker and the effected signal (Wet) is sent to the right speaker.

Note: When using a Wet/Dry setup, you may want to experiment with a higher mix level on the effect.

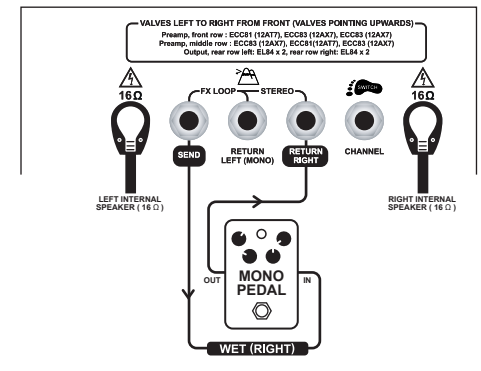

⚠ SPEAKER OUTPUTS ⚡

BOTH SPEAKER OUTPUT LEFT AND SPEAKER OUTPUT RIGHT ON THE ROCKER 32 MUST BE CONNECTED TO 16Ω SPEAKER LOADS AT ALL TIMES DURING OPERATION!