

Ampeg®

PF-350 / PF-500 / PF-800 Bass Guitar Amplifiers



Owner's Manual



TABLE OF CONTENTS

Introduction	2
PF-350 Features	3
PF-500 and PF-800 Features	3
PF-350 Front Panel	4
PF-350 Rear Panel	6
PF-350 Block Diagram	8
PF-350 Technical Specifications	9
PF-500 / PF-800 Front Panel	10
PF-500 / PF-800 Rear Panel	12
PF-500 / PF-800 Block Diagram	14
PF-500 / PF-800 Technical Specifications	15
Fault/Thermal Considerations	16
Flip-Top Instructions	16
Warranty and Support	17

Introduction

Portable. Powerful. Sexy. Ampeg designed and built the original Portaflex® Series amplifiers over 50 years ago. Congratulations are in order – for today, in your hands, is the new-and-improved Portaflex!

Featuring Class-D power and knobs galore, these beasts pack a mean punch, with a wide variety of tones at your disposal. Also, the switching power supply keeps the weight low, without sacrificing power output or our legendary sound quality.

Don't stop now! Your Portaflex amplifier is an ideal companion to the Ampeg PF-115HE, PF-115LF, PF-210HE, or PF-410HLF cabinet, available separately.

Like all Ampeg products, your Portaflex amplifier is designed by musicians and built using only the best of components. Each amplifier is tested to confirm that it meets our specifications, and we believe that this amplifier is the absolute best that it can be.

In order to get the most out of your new PF-350, PF-500, or PF-800 amplifier, please fully read this *Owner's Manual*, as well as the *Important Safety Instructions* included with your amplifier, before you begin playing.

And **thank you** for choosing Ampeg.

PF-350 Features

- Selectable -15 dB Input Pad
- Gain control
- Bass, Mid, and Treble controls
- Master Volume control
- Selectable Limiter and LED (PF-350 only)
- Peak LED
- Stereo 1/8" Auxiliary input
- Headphone output
- Effects loop with separate Send and Return jacks
- Balanced XLR line output
- Lightweight, fan-cooled switching power supply
- Voltage selector switch
- Class-D power amplifier rated at 350 Watts RMS into 4 Ω (PF-350)

PF-500 and PF-800 Features

The PF-500 and PF-800 Amplifier include all the preceding features of the PF-350, as well as the following:

- Dual JFET Preamp
- Mute switch
- Dual-function Mute and Peak LED
- On-board variable compressor
- Ultra Lo and Ultra Hi switches
- 5-way Midrange Frequency control
- FX Mix control
- Tuner Output
- Preamp Out and Power Amp In jacks
- Footswitch jack
- Single Speakon® & 1/4" Speaker Output jacks
- Class-D power amplifier rated at 500 Watts RMS into 4 Ω (PF-500)
- Class-D power amplifier rated at 800 Watts RMS into 4 Ω (PF-800)
- XLR Line Out features:
 - Pre/Post EQ
 - -40 dB Pad (mic/line level)
 - Ground Lift

PF-350 Front Panel

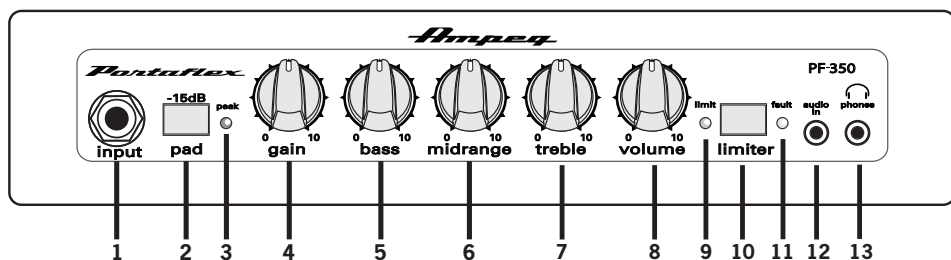

1. **INPUT:** The signal output from an instrument (active or passive) may be connected to this 1/4" Input by means of a shielded instrument cable.
2. **-15 dB PAD:** Press this switch in to reduce the input signal by 15 dB and compensate for higher output sources. This attenuation is suited for use with basses that have active electronics or high-output pickups. Use this Pad if you notice that the peak LED [3] comes on regularly. It will reduce the chance of over-driving the preamplifier stage, and allow more usable range and fine adjustment of the Gain control.
3. **PEAK LED:** This red warning LED will come on if the input signal is too high, the Gain control is set too high, or there is too much boost from the Bass, Midrange and Treble controls. If it comes on regularly, even when these controls are low, try engaging the -15 dB Pad [2].
4. **GAIN:** This varies the amount of signal driving the preamplifier. If a small clockwise rotation from minimum leads to overloading and the peak LED illuminating, try engaging the -15 dB Pad. This will give more usable range with the Gain control.
5. **BASS:** Use this to adjust the low frequency level of the amplifier. This provides up to 14 dB of boost, or -12 dB of cut, at 40 Hz. The low frequency output is flattest at the center position.
6. **MIDRANGE:** Use this to adjust the midrange frequency level of the amplifier. This provides up to 5 dB of boost, or -13 dB of cut, at 500 Hz. The midrange frequency output is flat at the center position. Rotate the control counter-clockwise for a "contoured" sound (more distant, less midrange output) or clockwise for a sound which really cuts through.

PF-350 Front Panel - Continued

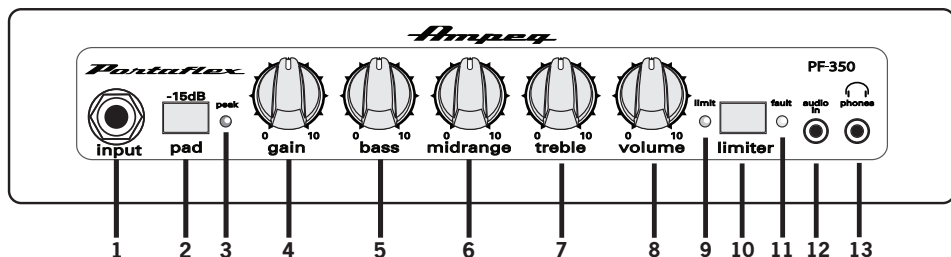

- 7. TREBLE:** Use this to adjust the high frequency level of the amplifier. This provides up to 19 dB of boost, or -25 dB of cut, at 8 kHz. The high frequency output is flattest at the center position.
- 8. VOLUME:** Use this to control the overall output level. It affects the Speaker Outputs and preamp level to the Headphone Output. Use it wisely and turn it down when making connections, putting on headphones, or trying something new.
- 9. LIMIT LED:** This LED illuminates when the Limiter circuit is activated, indicating that the amplifier is nearing full output, and the limiter is keeping peak signals from clipping the output.
- 10. LIMITER SWITCH:** Press this switch in to add the limiter circuit. If the signals driving the amplifier start to peak, the limiter will automatically reduce the signals to prevent clipping, and the Limit LED [9] will flash. The Limiter will help keep the amplifier's output "clean" up to high output levels and avoid potentially damaging distortion.
- 11. FAULT LED:** This LED illuminates amber if the amp thermals and shuts down or develops other fault conditions. See ["Fault/Thermal Considerations"](#) on [page 16](#) for more information.
- 12. AUDIO IN:** The audio output from line-level sources, such as a mobile device or MP3 player, can connect to this 1/8" TRS stereo input. The incoming audio is mixed with the preamp signals so you can play along to a practice track as you listen with headphones. (The audio coming in here only plays in the headphones, and appears nowhere else. It is not affected by the Volume control.)
- 13. PHONES:** Use this 1/8" TRS stereo output to connect your headphones. The output here is a mix of the line level signals reaching the amplifier, and any incoming audio from the Audio In jack [12].
- If you just want to listen and practice through headphones, disconnect the speaker outputs [18] from the speaker cabinet. There is no harm in playing the PF-350 without speakers.
-  Before putting on headphones, make sure the Volume control [8] is turned down, and (if connected) any external audio source has its level turned down. This will reduce the chance of hearing damage due to loud volumes.

PF-350 Rear Panel

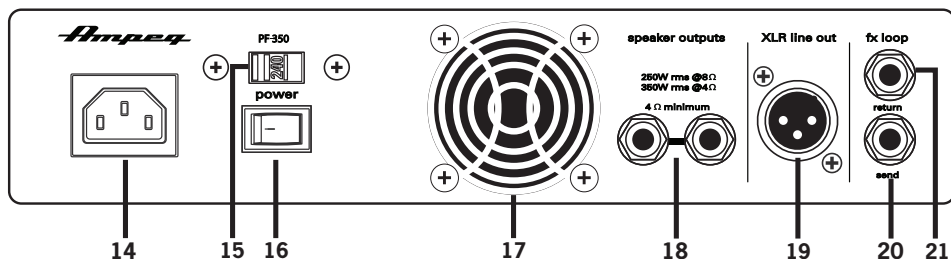

- 14. IEC POWER INPUT CONNECTOR:** This is where you connect the supplied AC power cord.
-  Before plugging in the power cord, make sure that the Voltage Selector Switch [15] is set to the same voltage as your local AC mains.
- 15. VOLTAGE SELECTOR SWITCH:** Make sure the switch is in the correct position for your local AC mains voltage before you plug in the AC power cord. Use a small flat screwdriver to slide the switch, if required.
- 16. POWER SWITCH:** Use this switch to turn the overall system power on or off. Press the switch to the left to turn on the power. Press the switch to the right to put the amp into Standby mode. (In Standby mode, the amp will not function, but the circuits are still live.) To remove AC power, either turn off the AC mains supply, or unplug the power cord from the amplifier and the AC mains supply.
- 17. VENTILATION:** Make sure that the ventilation openings are not obscured in any way. This will allow the flow of air to cool the power amplifier's heatsinks. See "Fault/Thermal Considerations" on page 16 for more information.

PF-350 Rear Panel - Continued

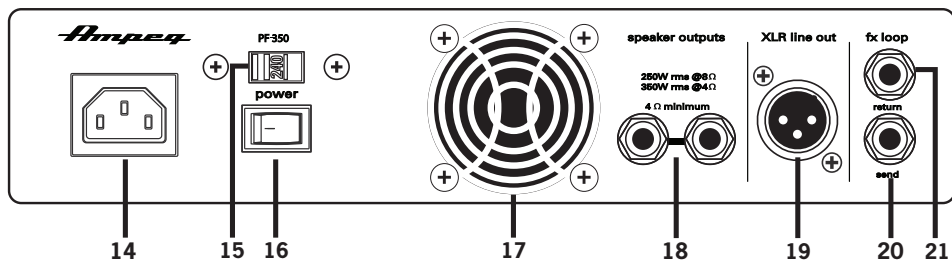

18. SPEAKER OUTPUTS: These 1/4" TS Speaker Output jacks supply speaker-level power to the speaker cabinet. The rated power output is 250 Watts RMS into 8 Ω , or 350 Watts RMS into 4 Ω .

 The two identical outputs are wired in parallel, and you can use either one, or use both. Make sure the total speaker impedance load is 4 Ω or greater.

For example, you could connect:

- Two 16 Ω speakers (an 8 Ω load),
- Two 8 Ω speakers (a 4 Ω load)
- One 4 Ω speaker

 Use (non-shielded) speaker cables with 1/4" TS ends to make the connections. Do not use (shielded) instrument cables as they may overheat.

19. XLR LINE OUT JACK: Typically, you would connect this balanced output to the balanced input of an external mixer or a recorder. In this way, you do not need to mic the speaker cabinet in order to add it to the main mix, or to record. This output is not affected by the Volume control [8].

This XLR Output can connect to external power amplifiers, or powered loudspeakers, as long as they include their own controls to adjust the volume level.

Balanced connections allow long cable runs to be used, as hum and noise pickup in the line is minimized.

20. FX SEND JACK: Use this 1/4" TS unbalanced output to send a line level output signal, for example, to an external effects processor. The output here is affected by all controls, except the Volume.

Use the FX Return jack to feed the returned processed signals back into the power amplifier.

21. FX RETURN JACK: Use this 1/4" TS, unbalanced input to return the processed line level output, for example, from an external effects processor. The processor can be fed by signals from the FX Send.

PF-350 Block Diagram

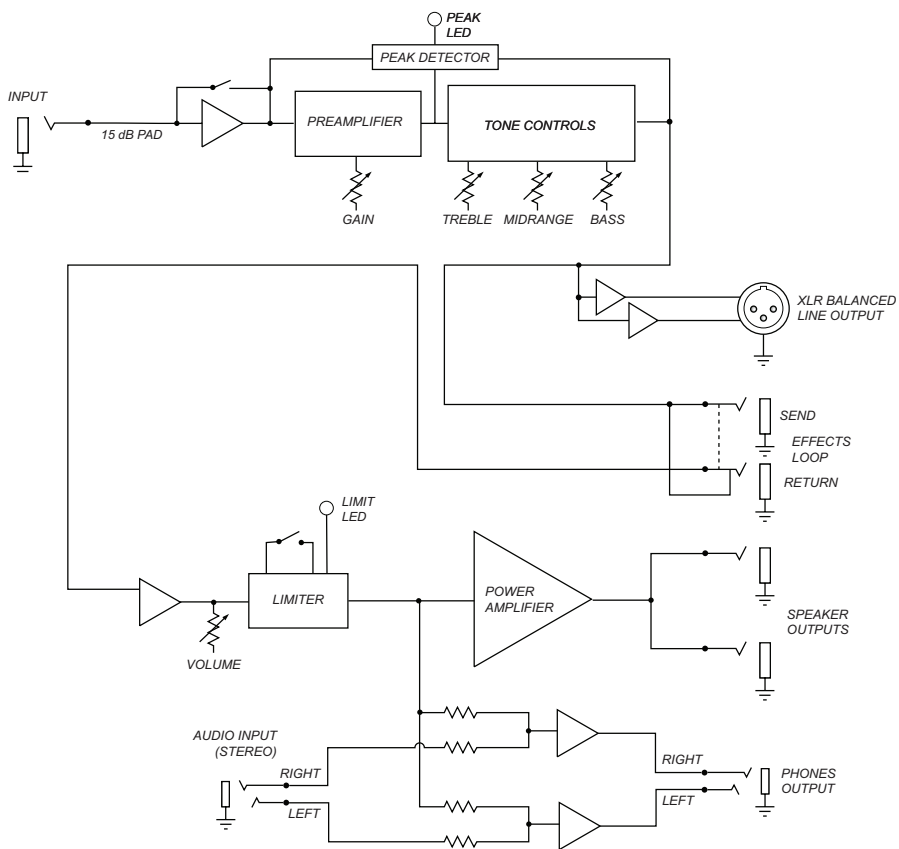

PF-350 Technical Specifications

Output Power Rating	250 Watts RMS @ 8 Ω , 5% THD 350 Watts RMS @ 4 Ω , 5% THD
Signal to Noise Ratio	75 dB (20 Hz–20 kHz, unweighted)
Maximum Gain	64 dB, tone controls centered
Tone Controls	Bass: +14/–12 dB @ 40 Hz Midrange: +5/–13 dB @ 500 Hz Treble: +19/–25 dB @ 8 kHz
Power Requirements	~100–120 VAC, 50–60 Hz, 100W ~200–240 VAC, 50–60 Hz, 100W
Size (H x W x D)	2.7 in / 69 mm x 10.8 in / 275 mm x 10.7 in / 272 mm
Weight	7.8 lb/3.5 kg (approximately)

The PF-350 is covered with sheet metal, so be sure to clean with a dry, lint-free cloth. Never spray cleaning agents on the PF-350. Avoid abrasive cleansers which would damage the finish.

Ampeg continually develops new products and improves upon existing ones. For this reason, the specifications and information in this manual are subject to change without notice.

PF-500 / PF-800 Front Panel

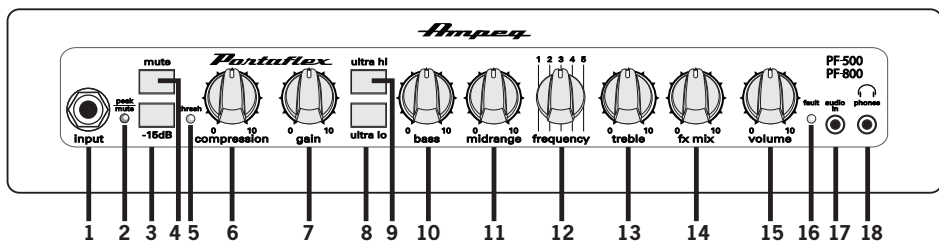

1. **INPUT:** The signal output from an instrument (active or passive) may be connected to this 1/4" Input by means of a shielded instrument cable.
2. **PEAK/MUTE LED:** This red warning LED will come on if: the Mute switch [4] is engaged, the input signal is too high, the Gain control is set too high, or there is too much boost from the Bass, Midrange and Treble controls. If it comes on regularly, even when these controls are low, try engaging the -15 dB Pad [3].
3. **-15 dB PAD:** Press this switch in to reduce the input signal by 15 dB and compensate for higher output sources. This attenuation is suited for use with basses that have active electronics or high-output pickups. Use this Pad if you notice that the Peak/Mute LED [2] comes on regularly. It will reduce the chance of overdriving the preamplifier stage, and allow more usable range and fine adjustment of the Gain control.
4. **MUTE:** Press this switch in to mute the signal. The Peak/Mute LED [2] will illuminate when this switch is engaged.
5. **THRESH LED:** This illuminates when the signal level exceeds the compressor's threshold and gain reduction is active.
6. **COMPRESSION:** This controls the amount of signal compression. At the fully counter-clockwise position, there is no compression; at the fully clockwise position, the compression ratio is 10:1. The sonic effect of compression is reduced dynamics, increased sustain and a more consistent output level, regardless of how light or hard the strings are played. The compressor is very transparent—that is, there is very little effect on the tone of your instrument.
7. **GAIN:** This varies the amount of signal driving the preamplifier. If a small clockwise rotation from minimum leads to overloading, and the Peak LED is illuminating, try engaging the -15 dB Pad. This will provide more usable range with the Gain control.
8. **ULTRA LO:** This switch, when engaged, enhances the amount of low-end output by 2 dB at 40 Hz, and implements a -10 dB cut at 500 Hz.
9. **ULTRA HI:** This switch, when engaged, enhances the amount of high frequency output by 9 dB at 8 kHz.
10. **BASS:** Use to adjust the low frequency level of the amplifier. This provides up to 12 dB of boost, or -12 dB of cut, at 40 Hz. The low frequency output is flat at the center position.
11. **MIDRANGE:** Use this to adjust the midrange frequency level of the amplifier. This provides up to 10 dB of boost, or -20 dB of cut, at the frequency selected. The midrange frequency output is flat at the center position. Rotate the control counter clockwise for a "contoured" sound (more distant, less midrange output), or clockwise for a sound that really cuts through.

PF-500 / PF-800 Front Panel - Continued

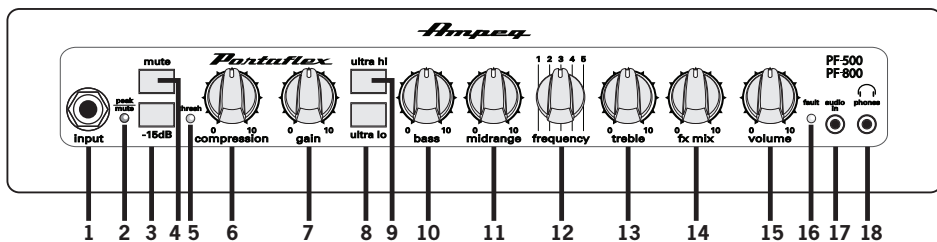

- 12. FREQUENCY:** This control allows you to select the center frequency for the Midrange control [11], giving you a choice of five center frequencies. The numbers correspond to the following center frequencies: 1=220 Hz, 2=450 Hz, 3=800 Hz, 4=1.6 kHz, 5=3 kHz.
- 13. TREBLE:** Use to adjust the high frequency level of the amplifier. This provides up to 15 dB of boost, or -20 dB of cut, at 4 kHz. The high frequency output is flat at the center position.
- 14. FX MIX:** This control varies the mix between the direct (dry) and the effects (wet) signals when the Effects Loop is used. Fully counter-clockwise results in all direct signal (no effect) and fully clockwise adds all effect (with no direct) signal. The fully clockwise position is equivalent to a series effects loop, and should be used with such devices as limiters and equalizers.
- 15. VOLUME:** Use to control the overall output level. It affects the preamp level to the Speaker and Phones Outputs. Use it wisely and turn down when making connections, putting on headphones, or trying something new.
- 16. FAULT LED:** This LED illuminates amber if the amp reaches its thermal limit and shuts down, or develops other fault conditions. See "[Fault/Thermal Considerations](#)" on page 16 for more information.
- 17. AUDIO IN:** The audio output from line level sources, such as a mobile device or MP3 player, can connect to this 1/8" TRS stereo input. The incoming audio is mixed with the preamp signals, so you can play along to a practice track as you listen with headphones. (The audio coming in here only plays in the headphones and appears nowhere else. It does not affect the signal fed to the Audio Input.)
- 18. PHONES:** Use this 1/8" TRS stereo output to connect your headphones. The output here is a mix of the line level signals reaching the amplifier and any incoming audio from the Audio In jack [17].
- If you just want to listen and practice through headphones, disconnect the Speaker Outputs [23] from the speaker cabinet. There is no harm in playing the PF-500 / PF-800 without speakers.
-  Before putting on headphones, make sure the Volume control [15] is turned down, and (if connected) any external audio source has its level turned down. This will reduce the chance of hearing damage due to loud volumes.

PF-500 / PF-800 Rear Panel

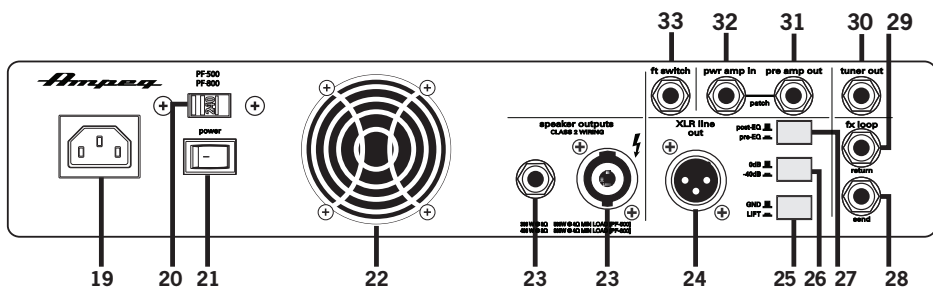

19. IEC POWER INPUT CONNECTOR: This is where you connect the supplied AC power cord.

 Before plugging in the power cord, make sure that the Voltage Selector Switch [20] is set to the same voltage as your local AC mains.

20. VOLTAGE SELECTOR SWITCH:

 Make sure the switch is in the correct position for your local AC mains voltage before you plug in the AC power cord. Use a small flat screwdriver to slide the switch if required.

21. POWER SWITCH: Use this switch to turn the overall system power on or off. Press the switch to the left to turn on the power. Press the switch to the right to put the amp into Standby mode. (In Standby mode, the amp will not function, but the circuits are still live.) To remove AC power, either turn off the AC mains supply, or unplug the power cord from the amplifier and the AC mains supply.

22. VENTILATION: Make sure that the ventilation openings are not obscured in any way. This will allow the flow of air to cool the power amplifier's heatsinks. See "[Fault/Thermal Considerations](#)" on [page 16](#) for more information.

23. SPEAKER OUTPUTS: These individual Speakon and 1/4" TS Output jacks connect to your speaker cabinet(s).

The rated power output of the PF-500 is 300 Watts RMS into 8 Ω , or 500 Watts RMS into 4 Ω . The rated power output of the PF-800 is 400 Watts RMS into 8 Ω , or 800 Watts RMS into 4 Ω .

 The two Speaker Outputs are wired in parallel, and you can use either one or both. Make sure the total speaker impedance load is 4 Ω or greater. For example, you could connect:

- Two 16 Ω speakers (an 8 Ω load),
- Two 8 Ω speakers (a 4 Ω load)
- One 4 Ω speaker

 Use (non-shielded) speaker cables with Speakon or 1/4" TS ends to make the connections. Do not use (shielded) instrument cables as they may overheat.

24. XLR LINE OUT JACK: Typically, you would connect this balanced output to the balanced input of an external mixer or a recorder. In this way, you do not need to mic the speaker cabinet in order to add it to the main mix or to record. This XLR Output is not affected by the Volume control [15].

This output can connect to external power amplifiers, or powered loudspeakers, as long as they include their own input controls to adjust the volume level.

Balanced connections allow long cable runs to be used, as hum and noise pickup in the line is minimized.

PF-500 / PF-800 Rear Panel - Continued

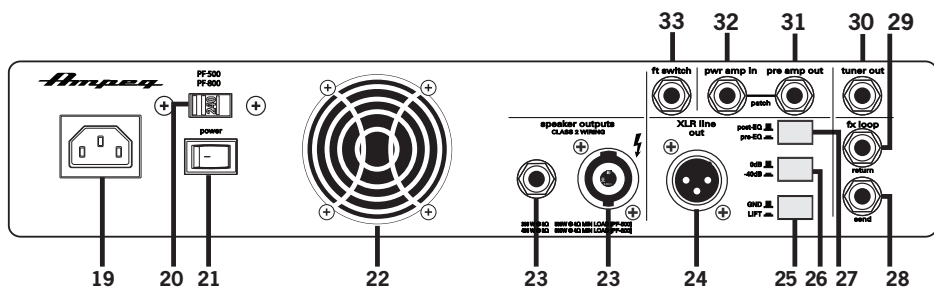

25. GROUND / LIFT: Press this switch in to engage the Ground Lift, if necessary, to help eliminate hum at the XLR jack.

26. 0 dB (line level) / -40 dB (mic level): Press this switch in to apply a -40 dB cut to the signal at the XLR Line Out [24].

27. POST-EQ/PRE-EQ: The signal at the XLR Line Out [24] can be set to either Pre-EQ or Post-EQ with this switch. With the switch in the IN position, the signal at the XLR Line Out is Pre-EQ, making it a direct output not affected by any EQ or boost settings. With the switch in the OUT position, the signal is Post-EQ and is controlled and modified by the tone controls, and FX Loop.

28. FX SEND JACK: Use this 1/4" TS unbalanced output to send a line level output, for example, to an external effects processor. This output is affected by all controls except the Volume.

Use the FX Return jack to feed the returned, processed signals back into the power amplifier.

29. FX RETURN JACK: Use this 1/4" TS unbalanced input to return the processed, line level output of, for example, an external effects processor. The processor could be fed by signals from the FX Send [28].

30. TUNER OUT: This jack acts as the only live output when the Mute switch is engaged. This allows for silent tuning through an electronic tuner or killing the house send with a monitor mixer send still active.

31. PREAMP OUT: This jack is a direct post Master preamp output for use with an external power amp. Connect the external amp's input to this jack using a shielded instrument cable.

32. POWER AMP IN: This jack connects directly to the internal power amp for use with an external preamp. When using an external source, connect the OUTPUT of the source to this jack using a shielded instrument cable to feed the signal into the power amp section. The internal signal is disconnected when a plug is inserted into this jack.

33. FOOTSWITCH: Connect a dual footswitch to this jack for remote Mute and FX On/Off control.* On the stereo (TRS) 1/4" plug, the tip controls Mute and the ring controls FX On/Off. The Mute function is available from either the front panel or the footswitch.

* **NOTE:** A footswitch (model #AFP2) may be purchased at your local Ampeg Dealer, or ordered directly from the Ampeg website, at <https://shop.ampeg.com/>.

PF-500 / PF-800 Block Diagram

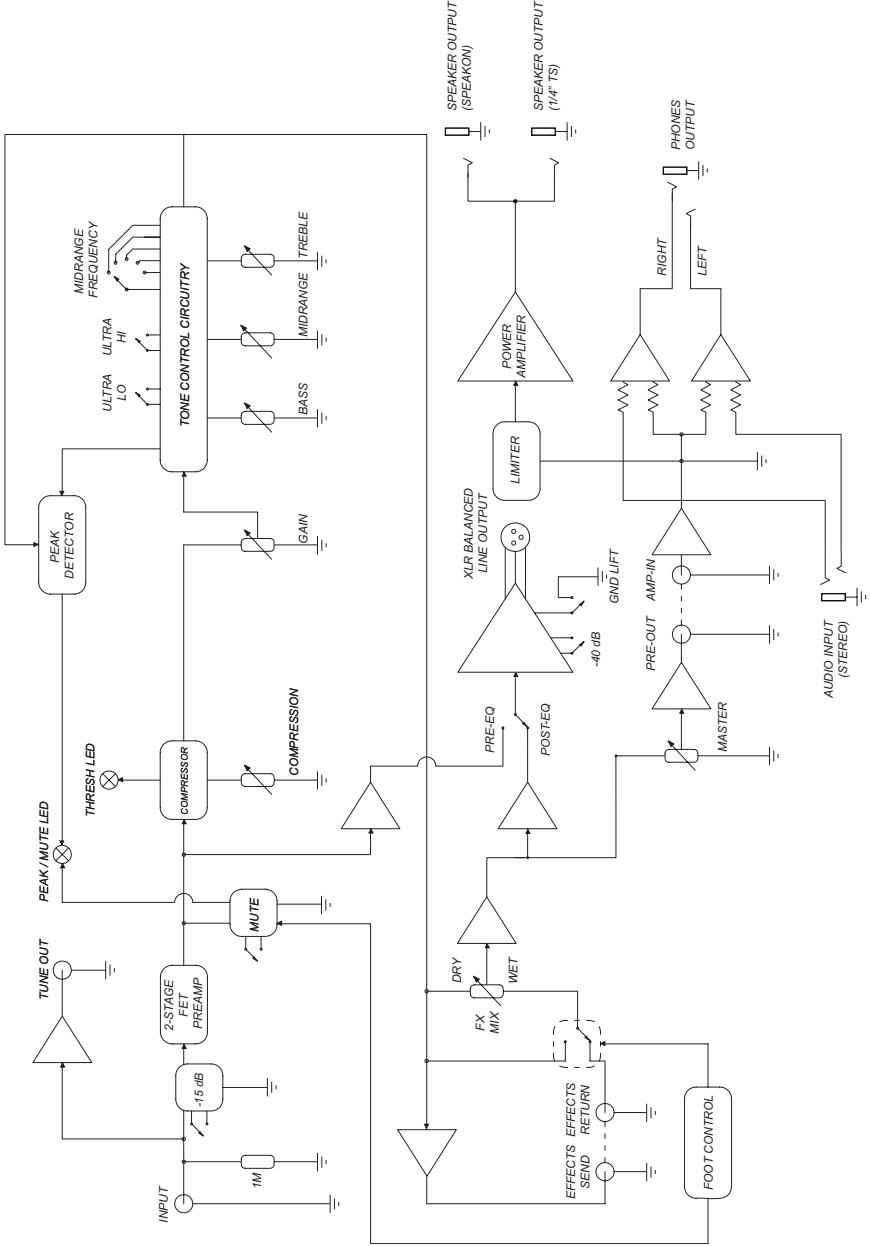

PF-500 / PF-800 Technical Specifications

Output Power Rating	300 Watts RMS @ 8 Ω , 3% THD [PF-500] 500 Watts RMS @ 4 Ω , 3% THD [PF-500] 400 Watts RMS @ 8 Ω , 3% THD [PF-800] 800 Watts RMS @ 4 Ω , 3% THD [PF-800]
Signal to Noise Ratio	72 dB (20 Hz–20 kHz, unweighted) [PF-500] 74 dB (20 Hz–20 kHz, unweighted) [PF-800]
Maximum Gain	69 dB, tone controls centered [PF-500] 71 dB, tone controls centered [PF-800]
Tone Controls	Bass: +12/–12 dB @ 40 Hz Midrange: +10/–20 dB @ 220 Hz, 450 Hz, 800 Hz, 1.6 kHz or 3 kHz Treble: +15/–20 dB @ 4 kHz
Power Requirements	~100–120 VAC, 50–60 Hz, 125W [PF-500] ~200–240 VAC, 50–60 Hz, 125W [PF-500] ~100–120 VAC, 50–60 Hz, 200W [PF-800] ~200–240 VAC, 50–60 Hz, 200W [PF-800]
Size (H x W x D)	3.1 in/80 mm x 14.0 in/355 mm x 10.8 in/272 mm [PF-500] 3.1 in/80 mm x 15.0 in/381 mm x 10.8 in/272 mm [PF-800]
Weight	11.0 lb/5.0 kg (approximately) [PF-500]

The PF-500/PF-800 is covered with sheet metal, so be sure to clean with a dry, lint-free cloth. Never spray cleaning agents on the PF-500/PF-800. Avoid abrasive cleansers which would damage the finish.

Ampeg continually develops new products and improves upon existing ones. For this reason, the specifications and information in this manual are subject to change without notice.

Fault/Thermal Considerations

As an amplifier works, it produces heat. The higher the signal level, the louder and hotter it gets. It is important to dissipate the heat as quickly as possible which, in turn, results in increased reliability and longevity for the amplifier.

The amplifier module is mounted on a large heatsink which is cooled by convection, where cool air is drawn through its fins, carrying the heat away. In order for this convection cooling to work efficiently, it is important to provide adequate airspace behind, to the side, and above the amplifier. When positioning your Portaflex amplifier, we recommend leaving at least six inches of air space behind it.

In the unlikely event of the amplifier overheating, a built-in Fault Switch will activate, muting the signal and lighting the Thermal LED. When the amplifier has cooled down to a safe operating temperature, the Fault Switch resets itself, and the Portaflex resumes normal operation.

If the Fault Switch activates frequently, try turning down the Volume control a notch or two to avoid overheating the amplifier. Be aware that direct sunlight and/or hot stage lights may also be the culprit of an amplifier overheating.

Flip-Top Instructions

So you've made it this far and you are now ready to flip your lid...or at least the amp. We will instruct you on how to do the latter, as we are not in the business of lid-flipping! This is accomplished in five simple steps:

- **Step 1:** Loosen the latches on each side of the cabinet. There are two latches on each side, four total.
- **Step 2:** Using the handle, lift the top of the cabinet (amplifier is attached underneath) and rotate it 180° clockwise (as indicated in the middle drawing below).
- **Step 3:** Set the cabinet top, handle-side down on the top of the cabinet. The amplifier should now be on the top, right-side up, with the front of the amp and the front of the cabinet facing the same direction.
- **Step 4:** Line up and lock all four latches.
- **Step 5:** Rock out like there is no tomorrow!

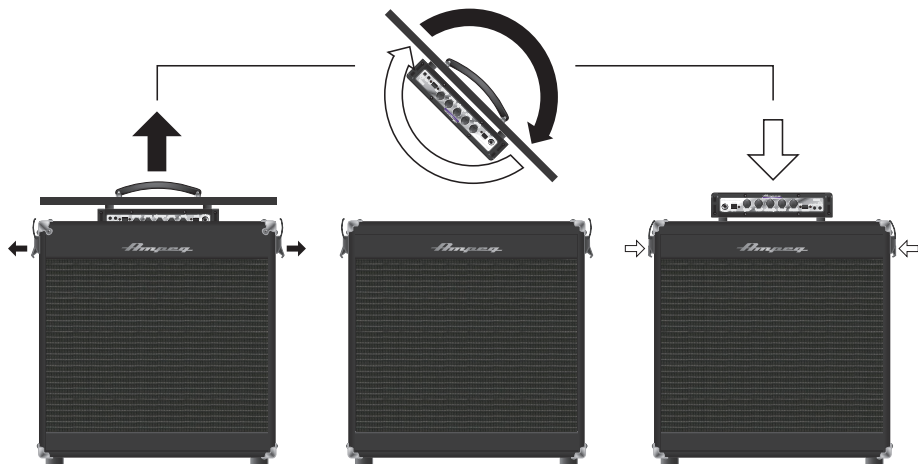

Warranty and Support

Visit **WWW.AMPEG.COM** to...

- (1) ...identify **WARRANTY** coverage provided in your local market. Please keep your sales receipt in a safe place.
- (2) ...**REGISTER** your product.
- (3) ...**CONTACT** Technical Support, or call 818-575-3600.

www.ameg.com
Yamaha Guitar Group, Inc.
26580 Agoura Road, Calabasas, CA 91302-1921 USA
Rev. A



© 2019 Yamaha Guitar Group, Inc. All rights reserved.

Ampeg, the Ampeg logo, and Portaflex are trademarks or registered trademarks of Yamaha Guitar Group, Inc. in the U.S. and/or other jurisdictions. Speakon is a registered trademark of Neutrik AG Corporation.