

Superlux®

E205U **USB CONDENSER** **MICROPHONE**

Contact

Marketing and sales

Goang-Fann Co., Ltd.

+886-2-26931323

sales@superlux.com.tw

support@superlux.com.tw

Manufacturing & logistics

Superlux Enterprise

Development (Shanghai) Co., Ltd.

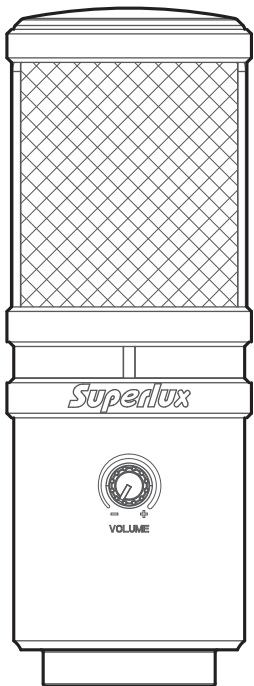

E205U

USB CONDENSER MICROPHONE

DESCRIPTION

The E205U is a high quality condenser microphone with an advanced A/D and USB interface which gives you digital recording capabilities instantly with no external digital interface or software driver required. It is USB compatible with Mac, Windows, and most DAW software programs, including GarageBand. The E205U offers premium quality audio recording with ease and mobility, and with its pivoting stand mount and 9.8 ft. (3-meter) USB cable, the E205U is a valuable kit for any project studio.

FEATURES

- Smooth, flat frequency response.
- Plug in and start recording, no drivers required.
- Up to 16 bit / 48 kHz sampling.
- Powered by USB power, no external power required.
- Headphone output and volume control.

E205U FREQUENCY RESPONSE (SUPERCARDIOID)

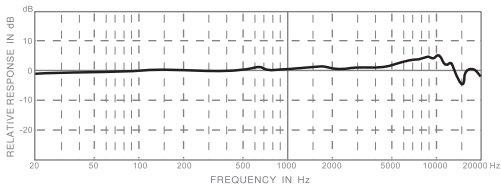
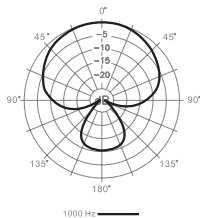

SPECIFICATIONS

*Note: Specifications are subject to change.

Type	Back Electret Condenser
Polar Pattern	Supercardioid
Frequency Response	30-18,000 Hz
Sensitivity (at 1k Hz Open Circuit Voltage)	-38 dBV/Pa (12.6 mV)
Max. SPL	>135 dB SPL
Power Requirements	USB 5V, 30 mA
Resolution	Up to 16 bit/48k Hz sampling rate
Finish	Champagne silver
Connectors	USB B-TYPE, 1/8"(3.5mm) phone connector
Dimensions	Ø54 × 150 mm (Ø2.13" × 5.9")
Net Weight	422 g (14.9 oz)

SYSTEM REQUIREMENTS

USB

USB 1.1 or 2.0, powered

OPERATING SYSTEM

Microsoft Windows 7

Microsoft Windows 10

Microsoft Windows 2000 Professional Edition

Microsoft Windows XP Home / Professional Edition

(service pack 1.0 or later, or use the USB audio driver update from Microsoft)

Microsoft Windows Vista™ Business Edition

Apple Computer Mac OS X 10.0 or later Edition

Apple Computer Mac OS X 10.1 or later Edition

RAM

64MB RAM (minimum)

FURNISHED ACCESSORIES



YA2 threaded
adapter



HM85 pivoting
stand mount



Pouch



3-meter
cable



DS01
Table stand

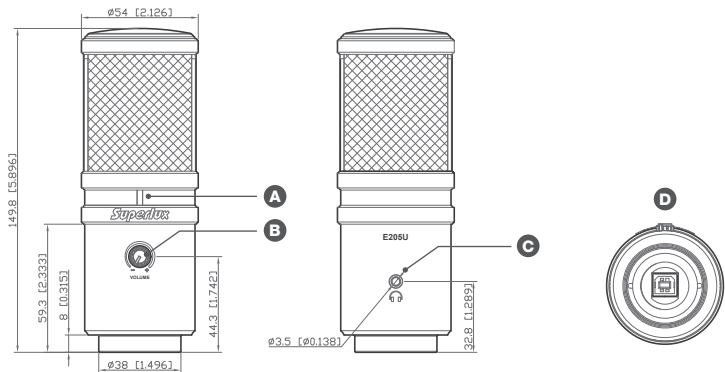

FUNCTION DESCRIPTION

A USB Power Indicator

When it is lit up, it means the USB connection is done and E205U get the power from USB interface.

B Headphone Volume Control

Pop-out level control to adjust the overall volume of the Headphone output.

C Headphone Output Jack

1/8-inch (3.5mm) stereo jack for connecting headphones or studio monitors.

D USB connector

E205U involves a USB B-type connector, it is allowed to connect to laptop with USB A-type jack.

INSTALLATION

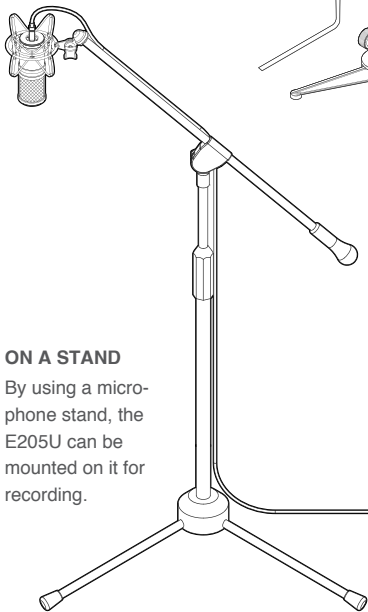

ON A STAND

By using a microphone stand, the E205U can be mounted on it for recording.

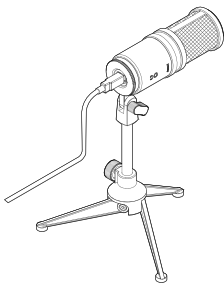

ON A TABLE

Through optional table stand HM6, You may put the E205U on a table and do recording.

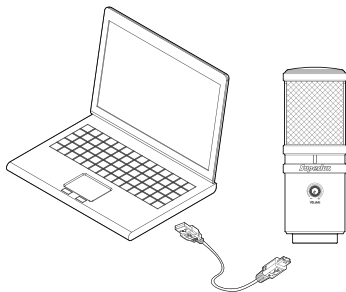

CONNECTIONS USB CONNECTOR

A separated 3-meter cable with USB A-type connector allowed to be connected to a computer with USB port.

***Notice:** The included USB cable is for laptop with A-type connector. For computer with another connector type (ex. C-type), please use connector adaptor.

QUICK START

1 You can position the E205U on an optional stand by using included accessories.

2 Be sure to position the side of grille net to the sound source and keep the Superlux logo and LED indicator face the direction of sound source.

3 Plug the B type connector of the included USB cable into the USB socket on the bottom of the E205U.

4 Now, plug the other end of the USB cable into an available powered USB port on your computer.

***Notice:** Be sure to check the USB audio device driver setup for Windows and Mac OS to confirm your computer has recognized the E205U.

5 Next, launch your DAW, turn down the main output level and select the E205U for the input.

6 Set up a mono record track in your DAW.

7 Now, setup the level of the E205U and there are few ways to do this depending on your computer system. You can set the microphone's input level in the Sound playback in Windows or in the Sound dialog box in the System Preferences if you are using the MAC OS.

8 Set level of the microphone by raising the Input level control in your DAW or system to about half way up.

9 Next, put on your headphones that is connected to the headphone output of E205U, position the E205U to the sound source then adjust the volume control until you reach a comfortable listening level.

Now, follow the instructions of your DAW software to enable the track for recording and you're ready to record.

***Notice:** If the microphone level of E205U are too loud or not enough, please check your DAW software or refer to Troubleshooting page in this manual to adjust the level in Windows and Mac computer system.

USB AUDIO EQUIPMENT DRIVER

If you encounter a problem, please check whether driver has been setup successfully.

WINDOWS OPERATING SYSTEM

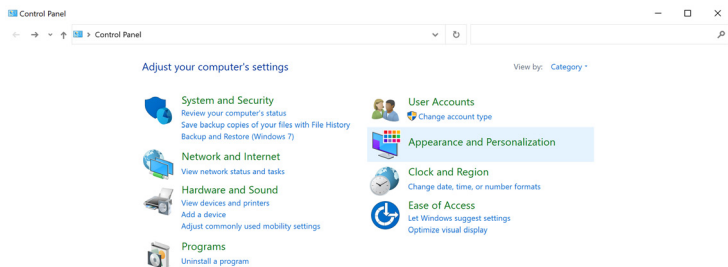

1 Hit "Control Panel" >> Hit "Hardware and Sound"

The screenshot shows the Windows Control Panel window titled "Hardware and Sound". The breadcrumb path is "Control Panel > Hardware and Sound". A search bar on the right contains the text "Search Control Panel".

Control Panel Home

- System and Security
- Network and Internet
- Hardware and Sound**
- Programs
- User Accounts
- Appearance and Personalization
- Clock and Region
- Ease of Access

Devices and Printers

- Add a device
- Advanced printer setup
- Mouse
- Device Manager
- Change Windows To Go startup options

AutoPlay

- Change default settings for media or devices
- Play CDs or other media automatically

Sound

- Adjust system volume
- Change system sounds
- Manage audio devices

Power Options

- Change battery settings
- Change what the power buttons do
- Change when the computer sleeps
- Choose a power plan
- Edit power plan

Windows Mobility Center

- Adjust commonly used mobility settings
- Adjust settings before giving a presentation

Pen and Touch

- Change tablet pen settings
- Turn flicks on and off
- Set flicks to perform certain tasks
- Change touch input settings

Tablet PC Settings

- Calibrate the screen for pen or touch input
- Set tablet buttons to perform certain tasks
- Choose the order of how your screen rotates
- Specify which hand you write with

2 Sound >> Hit "Manage audio devices"

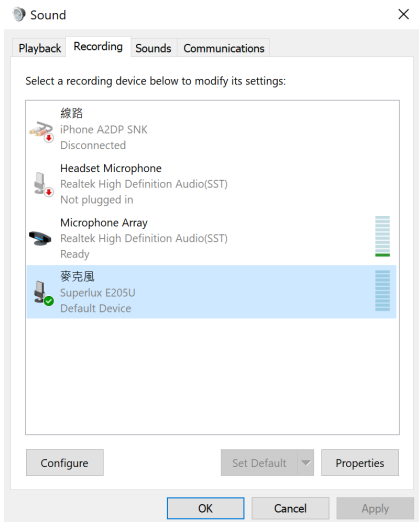

- 3** Hit “Recording” tab >> Click “Superlux E205U” >> Click “Set Default” to select Superlux E205U as the default microphone.

***Notice:** If there is already the green tick next to the E205U microphone symbol and the “Set Default” button is not able to be hit (dark gray color), the Superlux E205U has been selected as the default device successfully.

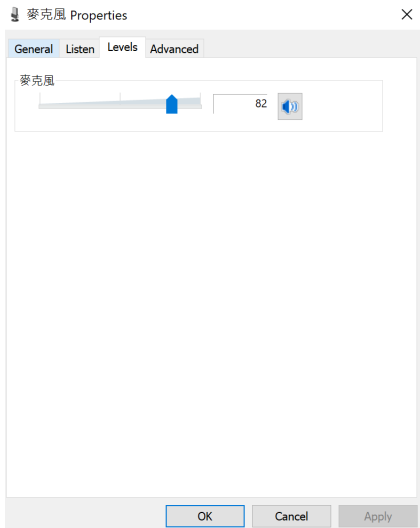

4 Hit "Properties" >> hit "Level" tab to adjust the microphone input gain.

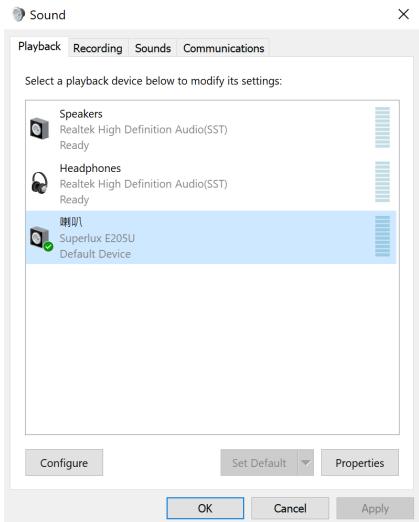

5

If you would like to use the equipped headphone output jack of E205U as the monitoring:

Hit "Playback" tab >> Click "Superlux E205U" >> Click "Set Default" to select Superlux E205U as the default microphone.

***Notice: If there is already a green tick next to the E205U speaker symbol and the "Set Default" button is not able to be hit (dark gray color), the Superlux E205U has been selected as the default device successfully.**

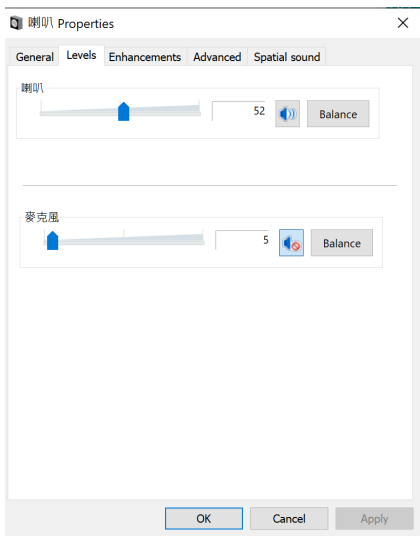

6

Hit "Properties" >> hit "Level" tab to adjust the headphone output volume. After that, please use the headphone volume knob on the E205U to do real-time adjustment.

MAC OS OPERATING SYSTEM

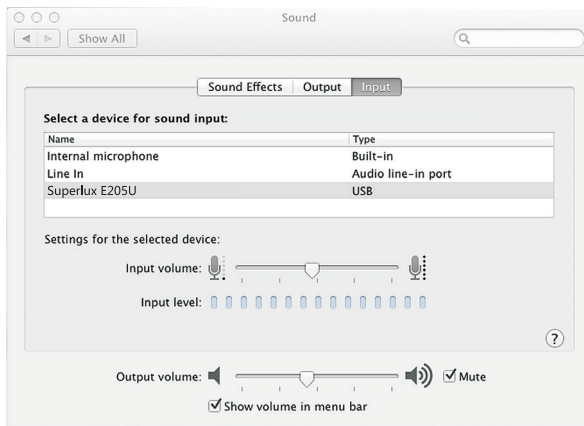

- 1 Open the Sound Preference window from System Preferences. Select Superlux E205U from both the Input and Output tabs.

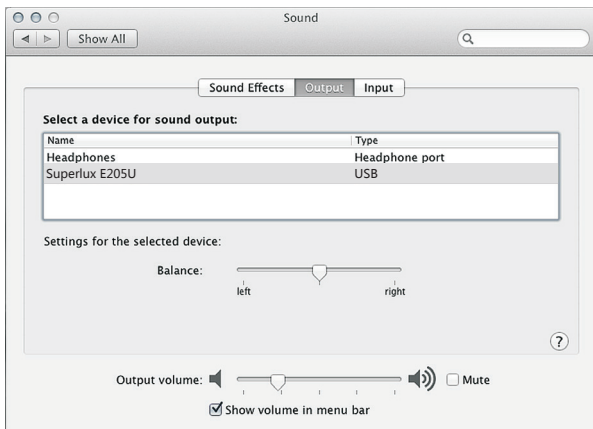

- Garage Band users:
- 2 open Garage Band before plugging in the microphone to automatically select the USB device.

MAC OS USING THE DIRECT MONITOR

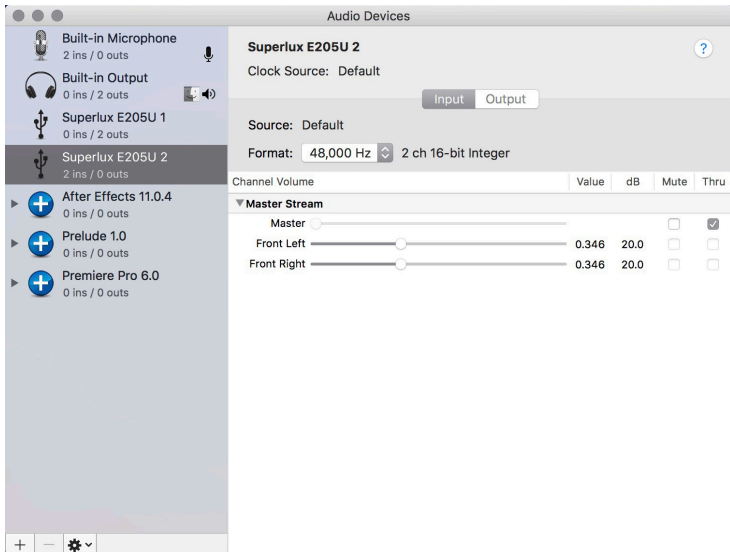

1

To turn direct monitoring on or off, open the **Audio/MIDI Setup** utility located in the **Utility** folder inside the Applications folder.

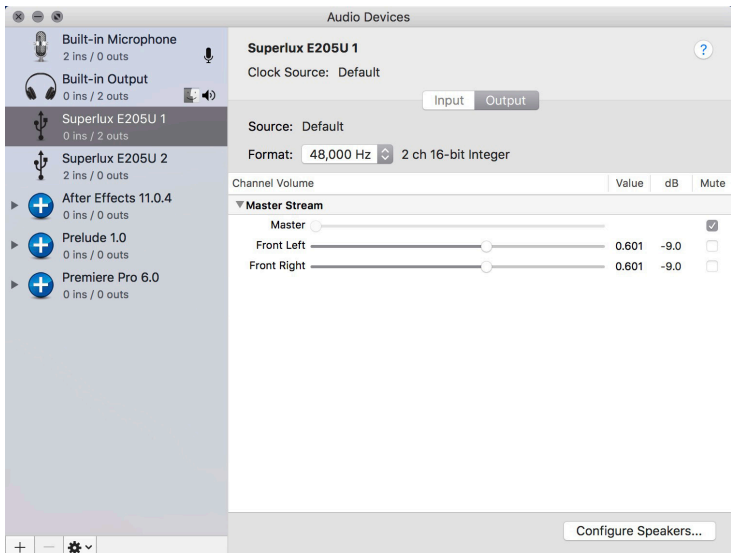

2 Now click the checkbox in the **Thru** column in **Audio/MIDI Setup**.

TROUBLESHOOTING

Problem	Solution
No sound in headphones	Check the headphone volume control and microphone gain at computer control panel.
Microphone sound is too weak or distorted	Windows: Audio tab, click Volume under Record and turn up Microphone Gain Control. Mac: From System Preferences, Choose Sound, Select Input tab and turn up Input gain.
Headphones are not loud enough	Windows: Audio tab, click Volume under Sound playback and turn up Volume Control. Mac: From System Preferences, Choose Sound, Select Output tab and turn up Output volume.



LIMITED WARRANTY

For compliance with the instructions which record in the user manual, Superlux Enterprise provide one year period warranty for all material and producing quality from purchase date. This warranty term will adjust according to different country or area. Please contact local distributor to receive more information. In the validity period, if there's any material, producing quality, or any function unavailable, Superlux will repair or replace the parts. This warranty is only for the product which selling by distributor or agent which authorized by Superlux.

However, the situation below is excluded in the warranty :

The damage which caused by accident, abuse, improper instructions, self-modification and repair, or damage from transportation, not complying with the instructions which record in the manual, repair by the company which didn't authorized by Superlux Enterprise, request by distributor without authorized, or the serial number sticker on Superlux product is unidentified, modified, or removed. All repair of Superlux products can only accept from repair centre, distributor or agent which authorized by Superlux. Unauthorized repair, maintenance and modification will not receive relevant warranty and will be excluded in the warranty. Any repair guarantee under warranty need to provide selling receipt from authorized distributor or agent to make sure your Superlux product still in the warranty period. To obtain the original authorized repair warranty, please contact authorized distributor, agent or send an e-mail to support@superlux.com.tw to contact us.



WARNING! INDICATES A POTENTIALLY HAZARDOUS SITUATION WHICH IF MISHANDLED COULD RESULT IN DEATH OR SERIOUS PERSONAL INJURY OR PROPERTY DAMAGE.

- ※Do not expose the unit to rain or an environment where it may be splashed by water or other liquids as doing so may result in fire or electric shock.
- ※Do not attempt to modify this product. Doing so could result in personal injury and/or product failure.
- ※Do not subject to extreme force and do not pull on the cable, it might cause the product failures.
- ※Keep this product and the equipment which used together dry and avoid to exposure to extreme high temperature and humidity.