

microKORG

SYNTHESIZER/VOCODER

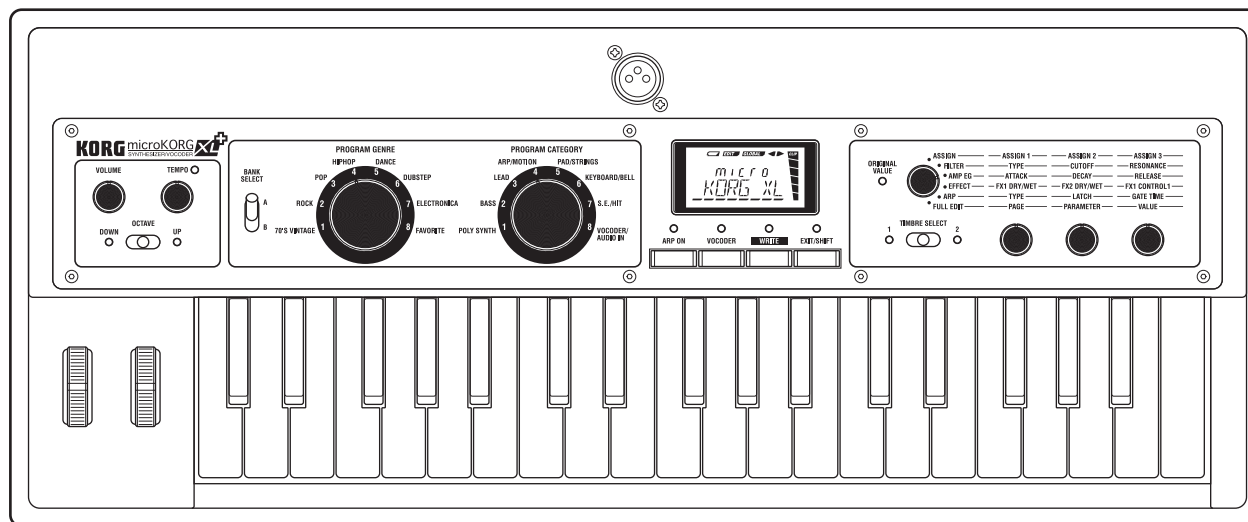

MMT

KORG

Owner's Manual

Precautions

Location

Using the unit in the following locations can result in a malfunction.

- In direct sunlight
- Locations of extreme temperature or humidity
- Excessively dusty or dirty locations
- Locations of excessive vibration
- Close to magnetic fields

Power supply

Please connect the designated AC adapter to an AC outlet of the correct voltage. Do not connect it to an AC outlet of voltage other than that for which your unit is intended.

Interference with other electrical devices

Radios and televisions placed nearby may experience reception interference. Operate this unit at a suitable distance from radios and televisions.

Handling

To avoid breakage, do not apply excessive force to the switches or controls.

Care

If the exterior becomes dirty, wipe it with a clean, dry cloth. Do not use liquid cleaners such as benzene or thinner, or cleaning compounds or flammable polishes.

Keep this manual

After reading this manual, please keep it for later reference.

Keeping foreign matter out of your equipment

Never set any container with liquid in it near this equipment. If liquid gets into the equipment, it could cause a breakdown, fire, or electrical shock.

Be careful not to let metal objects get into the equipment. If something does slip into the equipment, unplug the AC adapter from the wall outlet. Then contact your nearest Korg dealer or the store where the equipment was purchased.

THE FCC REGULATION WARNING (for USA)

NOTE: This equipment has been tested and found to comply with the limits for a Class B digital device, pursuant to Part 15 of the FCC Rules. These limits are designed to provide reasonable protection against harmful interference in a residential installation. This equipment generates, uses, and can radiate radio frequency energy and, if not installed and used in accordance with the instructions, may cause harmful interference to radio communications. However, there is no guarantee that interference will not occur in a particular installation. If this equipment does cause harmful interference to radio or television reception, which can be determined by turning the equipment off and on, the user is encouraged to try to correct the interference by one or more of the following measures:

- Reorient or relocate the receiving antenna.
- Increase the separation between the equipment and receiver.
- Connect the equipment into an outlet on a circuit different from that to which the receiver is connected.
- Consult the dealer or an experienced radio/TV technician for help.

If items such as cables are included with this equipment, you must use those included items. Unauthorized changes or modification to this system can void the user's authority to operate this equipment.

Data handling

Unexpected malfunctions can result in the loss of memory contents. Please be sure to save important data on an external data flier (storage device). Korg cannot accept any responsibility for any loss or damage which you may incur as a result of data loss.

** All product names and company names are the trademarks or registered trademarks of their respective owners.*

Notice regarding disposal (EU only)



When this "crossed-out wheeled bin" symbol is displayed on the product, owner's manual, battery, or battery package, it signifies that when you wish to dispose of this product, manual, package or battery you must do so in an approved manner.



Do not discard this product, manual, package or battery along with ordinary household waste. Disposing in the correct manner will prevent harm to human health and potential damage to the environment. Since the correct method of disposal will depend on the applicable laws and regulations in your locality, please contact your local administrative body for details. If the battery contains heavy metals in excess of the regulated amount, a chemical symbol is displayed below the "crossed-out wheeled bin" symbol on the battery or battery package.

Table of Contents

Introduction 5

1. Main features 5
2. Front and rear panels 6
 - Front panel 6
 - Rear panel 8

Preparations 9

1. Connections 9
2. Turning the power on 10
 - Before you turn on the power 10
 - Turning the power on 10
 - Turning the power off 11
 - Auto power off function 11

Quick start 12

1. Demo performance 12
 - Listening to the demo 12
2. Selecting and playing a program 12
 - Playing a synthesizer program 12
 - Playing a vocoder program 13
3. Modifying the sound 14
 - Using the controllers 14
 - Using the keyboard to modify the sound 14
 - Using the knobs to modify the sound 16

4. Playing arpeggios 18
 - Using the arpeggiator 18

Editing the sound 19

1. How a program is organized 19
 - Synthesizer 19
 - Vocoder 21
2. Basic editing procedure 22
 - Editing a program 22
3. Full Edit mode 23
 - Editing in Full Edit mode 23
 - Editing the two timbres 24
 - Editing the vocoder 25
 - Processing an external audio input 25
 - Editing the arpeggiator 26
4. About the Global settings 27
5. Other functions 28
 - Initializing a program 28
 - Copying a timbre 28
 - Transmitting programs and other data (Data Dump) 28
 - Restoring the factory settings 29

Saving (Writing) 31

1. Saving the settings you've edited 31
 - Saving a program 31
 - Saving global data 31

Parameter Guide 32

1. Timbre parameters 32

- 2. Arpeggio parameters..... 51**
 Front Panel Arpeggio Parameters..... 51
- 3. Edit utility parameters 54**
- 4. Vocoder parameters 54**
 Front panel vocoder parameters 54
- 5. Global parameters 57**
- 6. MIDI parameters 59**
- 7. Global utility parameters 62**

Effect guide 63

- 1. About the effects..... 63**
 About the effect input and output 63
 Controlling effect parameters 63
 About the delay time 64
- 2. Effect Parameters 65**

MIDI 80

- 1. Using the microKORG XL+ with other MIDI devices (MIDI)..... 80**
 Connecting MIDI devices/computers 80
 MIDI-related settings 81
- 2. MIDI messages 83**
 MIDI channels 83
 Note-on/off 83
 Program change, Bank select 84
 Pitch bend 84
 Control changes 84

- 3. Parameters transmitted and received via NRPN 86**
 Controlling the arpeggiator 86
 Controlling the Timbre parameters 87
 Controlling the vocoder parameters 88
 Other controls 89
 System exclusive messages 89
 Realtime Messages 89
- 4. Front panel knob/button control change assignments..... 90**

Appendices 94

- 1. Trouble shooting 94**
- 2. Program List 96**
- 3. Demo Song..... 98**
- 4. Specifications 99**
- 5. Index 100**

Introduction

Thank you for purchasing the Korg **microKORG XL+** Synthesizer / Vocoder. In order to take full advantage of your new instrument, please read this manual carefully and use the product as directed.

1. Main features

1. *Synthesizer functionality featuring MMT analog modeling*

The **microKORG XL+** provides a broad range of oscillator algorithms, including the sawtooth waves and square waves typical of analog synthesizers, as well as formant waveforms, noise, and PCM/DWGS waveforms. Based on these oscillator algorithms, you can produce a wide variety of tonal variations by applying simple operations.

2. *Performance editing with three knobs*

By turning three knobs to control parameters such as filter cutoff, resonance, and amp EG attack, you can vary the sound in an intuitive manner. Full Edit mode allows you to edit all of the **microKORG XL+**'s parameters.

3. *Vocoder functionality*

The **microKORG XL+** comes equipped with a vocoder function that will let you use your voice via a mic to process the sound of the oscillator, producing the impression that the instrument is "talking."

The vocoder consists of sixteen filter bands, which are able to create original vocoder sounds by shifting the filter frequencies or adjusting the level and pan of each band, as well as simulating the classic sounds of vintage vocoders.

4. *128 internal programs*

The **microKORG XL+** contains a total of 128 programs, organized into two banks (A and B.) Each bank contains eight genres, such as 70' Vintage and Rock and eight categories in each genre.

5. *Modify external audio input*

The sound of an instrument or other audio source received at the AUDIO IN jack can be processed in the same way as the internal waveforms.

6. *Virtual Patch functionality*

Controllers such as EG, LFO, keyboard tracking, and the wheels can be virtually connected to parameters such as pitch or cutoff, allowing you to modulate these parameters and create sounds with a high degree of freedom.

7. *Equalizer and effects add a final polish to your sounds*

Each timbre provides a two-band equalizer for additional sound-creating potential.

There are also two master effects for each program, allowing you to add final touches to your sound. You can choose one of seventeen types for each effect.

8. *Step Arpeggiator*

The built-in step arpeggiator can automatically generate an arpeggio when you hold down a chord.

You can choose from six types of arpeggio, and specify the duration and interval of the arpeggiated notes. Notes can also be individually switched on/off for up to eight steps, allowing you to vary the rhythm for an even wider range of possibilities.

9. *Sound editor software*

By using a USB cable to connect the **microKORG XL+** to your computer and using the sound editor software, you can edit all parameters from your computer. You can download the sound editor free of charge from the Korg website.

<http://www.korg.com/>

<http://www.korg.co.jp/English/Distributors/>

2. Front and rear panels

Front panel

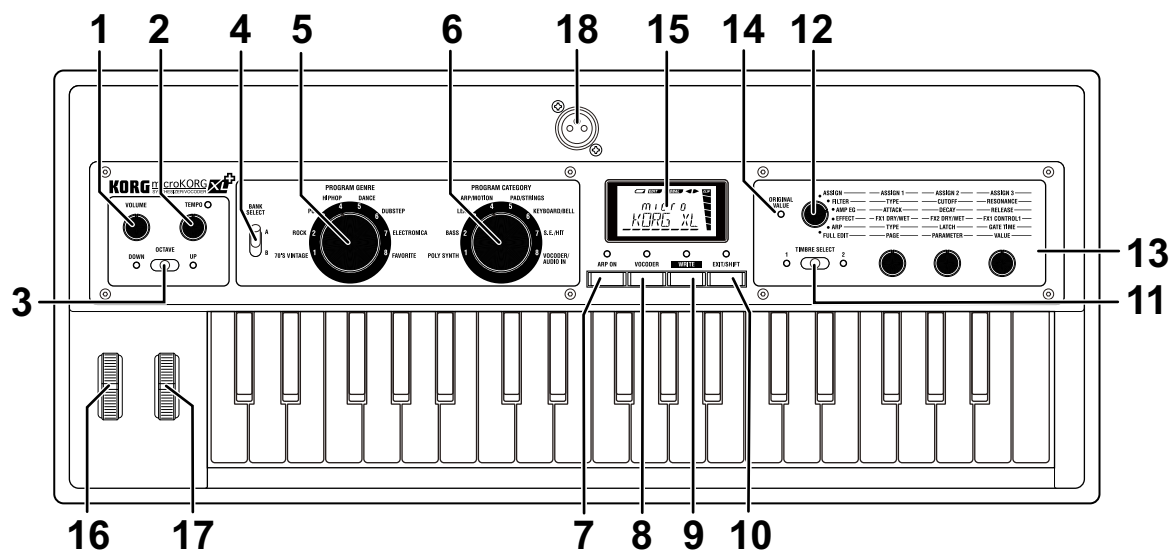

1. [VOLUME] knob

This adjusts the volume of the OUTPUT jacks (L/MONO, R) and headphone jack.

2. [TEMPO] knob

This adjusts the tempo (speed) of the arpeggiator, LFO, or delay effect. The LED above the knob will blink in synchronization with the tempo.

3. [OCTAVE] lever

This shifts the range of notes assigned to the keyboard upward or downward in one-octave steps over a range of 3 octaves. (→ p. 15)

NOTE If you want to make fine changes to this setting, you can hold down the [EXIT/SHIFT] button and use the OCTAVE lever to change the value in steps of one.

4. [BANK SELECT] lever

This selects the program bank.

5. [PROGRAM GENRE] dial

This dial selects the genre of program.

6. [PROGRAM CATEGORY] dial

This dial selects the category of program.

7. [ARP ON] (DEMO) button

This turns the arpeggiator on/off (→ p. 18). (When on, the LED above the button will be lit.)

If you hold down the [EXIT/SHIFT] button and press this button, a demo song will play. (→ p. 12)

8. [VOCODER] (AUDIO IN THRU) button

This turns the vocoder on/off (→ p. 13). (When on, the LED above the button will be lit.)

By holding down the [EXIT/SHIFT] button and pressing this button, you can switch the AUDIO IN THRU setting (→ p. 13).

9. [WRITE] button

Press this button to save a program or global settings you've edited (→ p. 31).

10. [EXIT/SHIFT] button

Press this button to stop a Save or Utility operation.

By pressing this button in conjunction with another button, you can play a demo or switch the AUDIO IN THRU setting.

11. [TIMBRE SELECT] lever

Use this to select the timbre that you want to edit (→ p. 22).

The selected timbre is indicated by the lit LED beside this lever.

NOTE If the COMMON page setting "VOIC.MODE" is "SINGLE," the [TIMBRE SELECT] lever does nothing.

12. [KNOB FUNCTION SELECT] dial

This dial selects the function of knobs [1], [2], and [3].

If the dial is set to ASSIGN, FILTER, AMP EG, or ARP, the timbre selected by the [TIMBRE SELECT] lever will be the target of your editing, and you'll be able to use the performance edit functions (→ p. 22).

If the dial is set to EFFECT, performance editing will control the dry/wet balance for FX1 and FX2 and the parameter that's assigned to Control 1 of FX1.

If the dial is set to FULL EDIT, the knobs will operate in full edit mode, allowing you to select a page and parameter, and to edit the value of that parameter (→ p. 23).

13. [1], [2], [3] knobs

Use these knobs for performance editing and in full edit mode to select the page, parameter, and parameter value.

14. ORIGINAL VALUE LED

This LED will light when the value of the parameter you're editing matches the value stored in the program.

15. Display

Information on the selected program is shown here. In full edit mode, the display shows the selected page, the current value of the parameter, various messages, or other information.

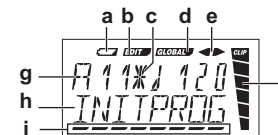

a: Battery empty indicator

b: Edit indicator

c: This will appear when the position of the [PROGRAM GENRE] dial, [PROGRAM CATEGORY] dial, or [BANK SELECT] lever no longer matches the actual program number, such as when a MIDI program change message has been received.

d: Global indicator

e: When "KNOB MODE" is CATCH, this indicates the direction of the actual value relative to the knob position.

f: Level meter

g, h: These areas display program information, or indicate the parameter or parameter.

i: Cursor

16. [PITCH] wheel

This controls the pitch.

17. [MOD] wheel

This controls the depth of modulation.

18. AUDIO IN [MIC] (XLR) jack

You can connect a mic here.

If you want to use a mic connected to this jack, set the rear panel [XLR/LINE] switch to the "XLR" position. Use the rear panel AUDIO IN [LEVEL] knob to adjust the level.

Rear panel

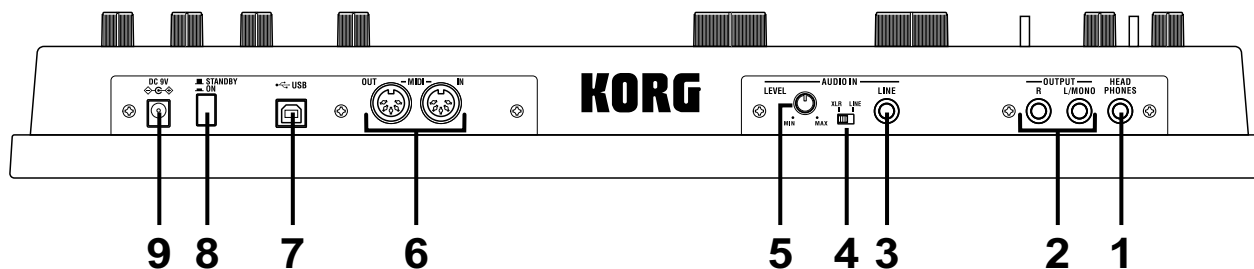

1. [HEADPHONES] jack

You can connect headphones to this jack (stereo 1/4").

2. OUTPUT [L/MONO], [R] jacks

You can connect powered monitors, a stereo amp, mixer, or multi-track recorder to these jacks.

If you're using a monaural connection, connect the [L/MONO] jack.

3. AUDIO IN [LINE] jack

This is a monaural audio input jack. Use the AUDIO IN [LEVEL] knob to adjust the level.

For a synth program, you can connect another synthesizer or audio device to this jack and use the input audio as the oscillator 1 waveform.

For a vocoder program, you can use the input audio as the modulator signal.

4. AUDIO IN [XLR/LINE] switch

Set this to the "LINE" position if you're using the AUDIO IN [LINE] jack on the rear panel, or to the "XLR" position if you're using the AUDIO IN [MIC] jack on the front panel.

5. AUDIO IN [LEVEL] knob

This adjusts the input level from the AUDIO IN [MIC] or [LINE] jacks.

6. MIDI

These connectors allow the **microKORG XL+** to exchange MIDI messages with an external MIDI device.

[MIDI IN] connector

This connector receives MIDI data.

[MIDI OUT] connector

This connector transmits MIDI data.

7. [USB] connector

This connector allows the **microKORG XL+** to exchange MIDI messages with your computer. You can also use sound editor software to edit the **microKORG XL+**'s parameters.

NOTE In order to use a USB connection, you'll need to install the Korg USB-MIDI driver in your computer. Download the "Korg USB-MIDI driver" from the Korg website, and install it as described in the accompanying documentation.

NOTE You can download the sound editor software from the Korg website.

8. Power switch

This turns the power on/off.

9. [DC 9V] connector

Connect the included AC adapter here.

Connect the AC adapter to the **microKORG XL+** before you plug it into an AC outlet.

Preparations

1. Connections

The illustration below shows a typical example of connections for the **microKORG XL+**. Connect your equipment as appropriate for your needs.

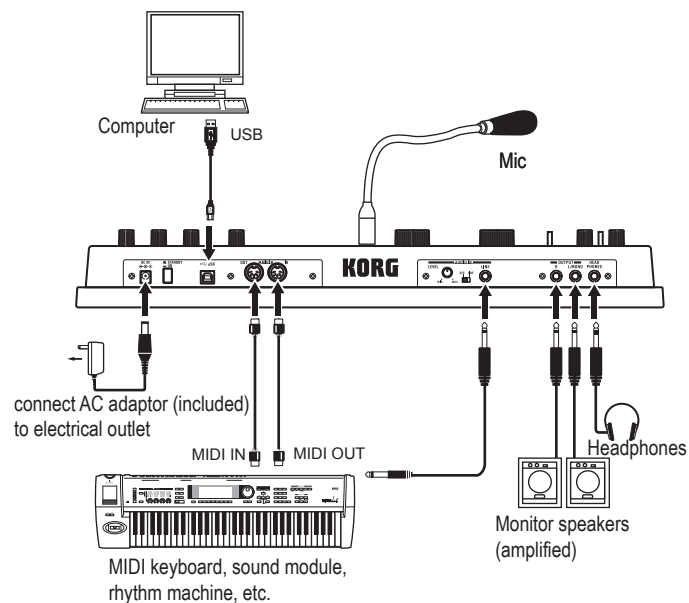

 You must make connections with the power turned off. Failure to observe this precaution may cause malfunctions or damage to your speaker system.

Connect your monitor amp or mixer to the output jacks

Connect the **microKORG XL+**'s OUTPUT [L/MONO], [R] jacks to the input jacks of your mixer or powered monitor speakers. If you make connections in monaural, use the [L/MONO] jack.

NOTE We recommend that you output in stereo to take full advantage of the **microKORG XL+**'s sound.

Connect your mic or sampler to the input jack

If you're using the **microKORG XL+** as a vocoder, connect the mic to the AUDIO IN [MIC] jack so that the mic audio can be used as a modulator (→ p. 21).



If you're using the **microKORG XL+** to process the sound of a synthesizer or sampler, connect the output of your external device to the **microKORG XL+**'s AUDIO IN [LINE] jack.

NOTE The AUDIO IN [LINE] jack is monaural.

Connecting the included mic

The **microKORG XL+** comes with a mic for use with the vocoder.

If you want to connect the included mic, plug it into the front panel AUDIO IN [MIC] jack. To disconnect it, grasp the base of the mic and pull it out.

-  Do not use excessive force when connecting or disconnecting the mic.
-  Do not apply excessive force to the mic's gooseneck, or repeatedly bend it more than necessary. Doing so may cause broken wires or other malfunctions.

If you've connected a mic to the **microKORG XL+**'s front panel AUDIO IN [MIC] jack, set the AUDIO IN [XLR/LINE] switch to "XLR."

-  Be careful of the mic output level when connecting a mic.

Connecting MIDI equipment or a computer to the MIDI connectors or USB connector



If you want to use the **microKORG XL+**'s keyboard and controllers to control an external MIDI device, or if you want to use another MIDI keyboard or a sequencer to play the **microKORG XL+**'s sound generator, then use USB/MIDI or the onboard MIDI connections. (→ p. 80 "1. Using the **microKORG XL+** with other MIDI devices (MIDI)")

2. Turning the power on

Before you turn on the power

Make sure that the power switch is off before you connect the power supply.

Connecting the AC adapter

1. Make sure that the **microKORG XL+** is powered-off.
2. Connect the included AC adapter to the DC9V jack located on the rear panel.
 -  Use only the included AC adapter. Using any other AC adapter may cause malfunctions.
3. Plug the AC adapter into an AC outlet.
 -  Use an AC outlet of the correct voltage.

Using batteries

The **microKORG XL+** can also operate on batteries.

NOTE Batteries are not included. You'll need to purchase them separately.

Installing/replacing the batteries

1. Make sure that the **microKORG XL+** is powered-off.
2. Open the battery cover located on the bottom of the **microKORG XL+**.
3. Insert six AA alkaline batteries (sold separately).

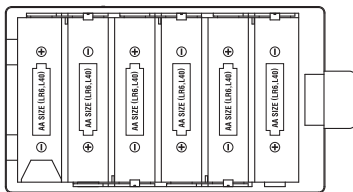

 Make sure that the batteries are oriented correctly.

4. Close the battery cover.

About the battery empty indicator

When the battery capacity runs down, the “” indicator will appear on the display. If you continue to use the unit in this state, the indicator will begin blinking, and the Write Protect setting will automatically be enabled, making it impossible to save programs or global settings. We recommend that you replace the batteries as soon as possible, or use the AC adapter. If you are in the middle of editing when this state occurs, and need to save the changes you've made, you'll need to connect the AC adapter so that you can execute the Write operation.

 Depleted batteries should be immediately removed from the **microKORG XL+**. Leaving depleted batteries installed may cause malfunctions (such as leakage of the battery electrolyte). You should also remove the batteries if you won't be using the **microKORG XL+** for an extended period of time.

Turning the power on

 Before you power-on the **microKORG XL+**, you must power-off any external output device such as your powered monitor speakers.

1. Turn the **microKORG XL+**'s [VOLUME] knob all the way to the left.
2. Press the power switch to turn on the power.
The display will indicate the program number and program name.
3. Lower the volume of your powered monitors or other external output equipment.
4. Turn the **microKORG XL+**'s [VOLUME] knob to an appropriate position.
5. Adjust the volume of your external output equipment.

Turning the power off

After completing any necessary operations such as saving your edited program, turn off the power using the following procedure.

 Never turn off the power while data is being saved (i.e., while executing the Write operation). Doing so may destroy internal data.

1. Lower the volume of your powered monitor speakers or other external output device, and then turn off their power.
2. Turn the [VOLUME] knob of the **microKORG XL+** all the way toward the left, and then press and hold down the power switch until the display indicates that you can safely turn off the power.

Auto power off function

If there is no user input for approx. 4 hours the auto power off function, which automatically turns off the microKORG XL+, will be activated. This function can be disabled so that the microKORG XL+ is not automatically turned off.

NOTE With the factory settings, the auto power off function is enabled.

 When the microKORG XL+ is turned off, any edited settings will be lost. If you want to use the settings again, be sure to save (write) them first.

Changing the auto power off setting

1. Use the [KNOB FUNCTION SELECT] dial to select “FULL EDIT.”
2. Use knob [1] to select the GLOBAL page, use knob [2] to select “A.PWR.OFF,” and then use knob [3] to change the setting.

If you do not want the microKORG XL+ to automatically be turned off with the auto power off function, select “DISABLE.”

3. Save the setting. (→p. 31 “Saving global data”)

Quick start

1. Demo performance

Listening to the demo

The **microKORG XL+** contains demo songs that show off its sounds (→ p. 98 “3.Demo Song”).

1. Hold down the [EXIT/SHIFT] button and press the [ARP ON] button.
The demo performance will begin.
2. You can use the [1] knob to switch songs during the demo.
3. Press the [EXIT/SHIFT] button to end the demo performance.

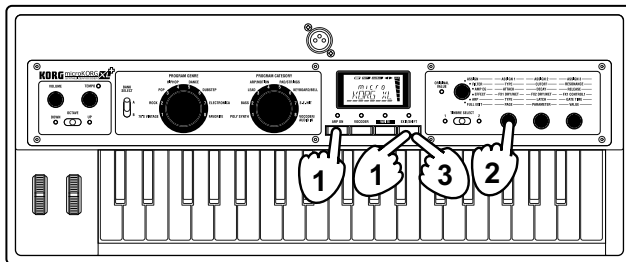

2. Selecting and playing a program

Playing a synthesizer program

The **microKORG XL+** contains 128 programs that you can play immediately.

To select a program, you'll use the panel PROGRAM GENRE dial, PROGRAM CATEGORY dial, and BANK SELECT lever.

You are free to select the sound according to its musical style (Program Genre) or by its musical role (Program Category)—simply start with the dial that you find most convenient.

Try out the various programs and listen to the sounds that they offer.

As an example, here's how to select a sound from the BASS category for use in a song in the ROCK genre.

1. Turn the [PROGRAM GENRE] dial to “ROCK”.
2. Turn the [PROGRAM CATEGORY] dial to “BASS.”
The display will indicate the name of the selected program.
NOTE The program will change when you switch the bank or number.
3. Play the keyboard to hear the sound.
You can use the [OCTAVE] lever to change the assigned pitch range. (→ p. 15 “Using the [OCTAVE] lever to switch octaves”)
4. Use the [BANK SELECT] lever to switch sounds.
While playing the keyboard, compare the sounds of the two banks to see which one you like best.

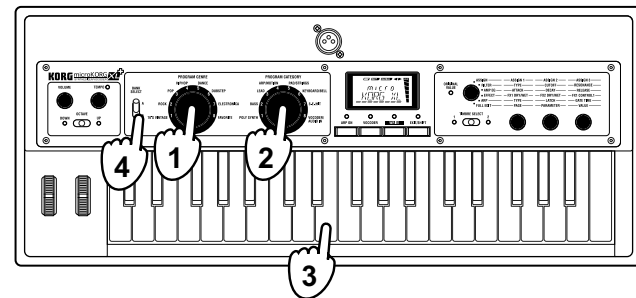

Playing a vocoder program

A vocoder modifies the signal from an oscillator or other source (the “carrier”) by applying the spectral characteristics of an external input source such as a human voice (the “modulator”).

The most common way to use a vocoder is to produce a “talking instrument” effect by taking the input of your voice from the mic while you hold down a chord on the keyboard. However you can also obtain interesting results by using audio input sources other than a human voice, such as rhythm sounds or anything you like. Here’s how to connect a mic and try out the vocoder.

1. Turn the rear panel AUDIO IN [LEVEL] knob all the way to “MIN.”
2. Connect the mic to the front panel AUDIO IN [MIC] jack (→ p. 9 “Connecting the included mic”).
3. Set the rear panel [XLR/LINE] switch to “XLR.”
4. Select a vocoder program.

With the factory settings, category 8 or program A18, A28 etc. contains vocoder programs. When you select a vocoder program, the [VOCODER] button LED will light.

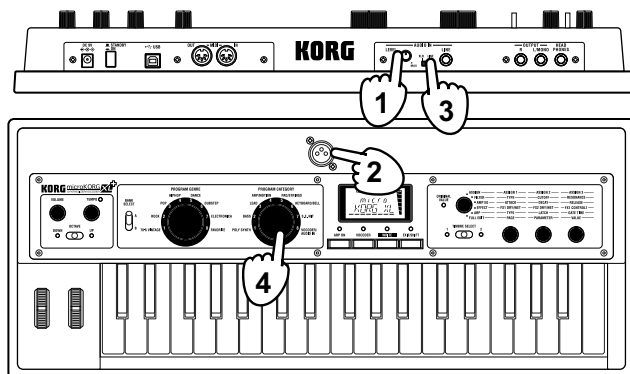

5. Adjust the mic input level.

While vocalizing into the mic, turn the AUDIO IN [LEVEL] knob toward the right as far as possible without allowing the “CLIP” indication to appear in the level meter shown to the right of the display.

NOTE If you want to audition the audio input directly, hold down the [EXIT/SHIFT] button and press the [VOCODER] button (→ p. 13).

6. While vocalizing into the mic, play the keyboard.

To hear different vocoder effects, try vocalizing in different ways and changing the chord you play.

NOTE If you’re unable to hear the effect, adjust the VC CARRI page “TMBR1.LVL” parameter or the VC AMP page “VC LEVEL” parameter (→ p. 54, → p. 56).

NOTE Some vocoder programs will produce sound when you simply play the keyboard; there’s no need to vocalize into the mic.

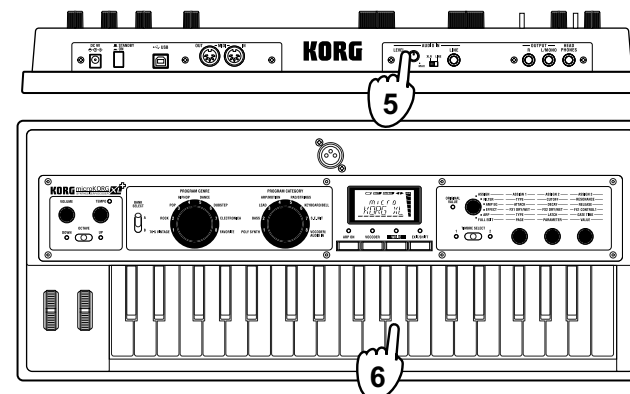

Listening to the audio input (AUDIO IN THRU)

If you hold down the [EXIT/SHIFT] button and press the [VOCODER] button, the audio input signal from the AUDIO IN [MIC] jack or the AUDIO IN [LINE] jack will be sent from the OUTPUT [L/MONO], [R] jacks without modification.

To return to the normal state, hold down the [EXIT/SHIFT] button and press the [VOCODER] button once again.

3. Modifying the sound

To make your performance more expressive, you can modify the sounds of the **microKORG XL+** by using the [1]–[3] knobs, the [PITCH] wheel, the [MOD] wheel, and by how you play the keyboard. Try out various ways to play each program you select.

Using the controllers

Using the [PITCH] wheel and [MOD] wheel

[PITCH] wheel

The effect will be applied when you move the wheel away from or toward yourself; there will be no effect when the wheel is in the center. This wheel is normally used as a pitch bender; moving the wheel away from yourself will raise the pitch, and moving it toward yourself will lower the pitch.

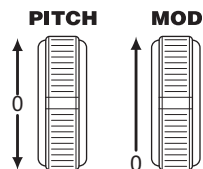

[MOD] wheel

The effect will apply when you move the wheel away from yourself; there will be no effect when the wheel is all the way toward yourself. This wheel is typically used to vary the vibrato depth or to modify the tone by changing the cutoff frequency.

NOTE You can use the [PITCH] and [MOD] wheels as virtual patch sources.

They can be used to control a wide variety of effects in addition to those described above (→ p. 49).

Using the keyboard to modify the sound

Velocity

The effect will vary depending on the amount of force that you play the keys with. Normally, the force of your strike will affect the tone or volume.



The **microKORG XL+**'s keyboard does not support aftertouch.

Keyboard tracking

The effect will vary according to the keyboard position (higher or lower notes) that you're playing in. Normally, keyboard tracking is assigned to make the sound brighter as you play upward on the keyboard, or to produce differences in the volume of higher and lower notes (→ p. 44).

NOTE You can use keyboard tracking and velocity as virtual patch sources.

Using the [OCTAVE] lever to switch octaves

The area of pitches assigned to the keyboard can be changed in one-octave steps over a range of +/-3 octaves.

Lever operation	Keyboard range	Key LED	Lever operation
Move toward DOWN	C6-C9	UP LED lit red	Move toward UP
↓	C5-C8	UP LED lit orange	↑
↓	C4-C7	UP LED lit green	↑
DOWN ○	C3-C6	dark	UP ○
↓	C2-C5	DOWN LED lit green	↑
↓	C1-C4	DOWN LED lit orange	↑
↓	C0-C3	DOWN LED lit red	↑

Quick start

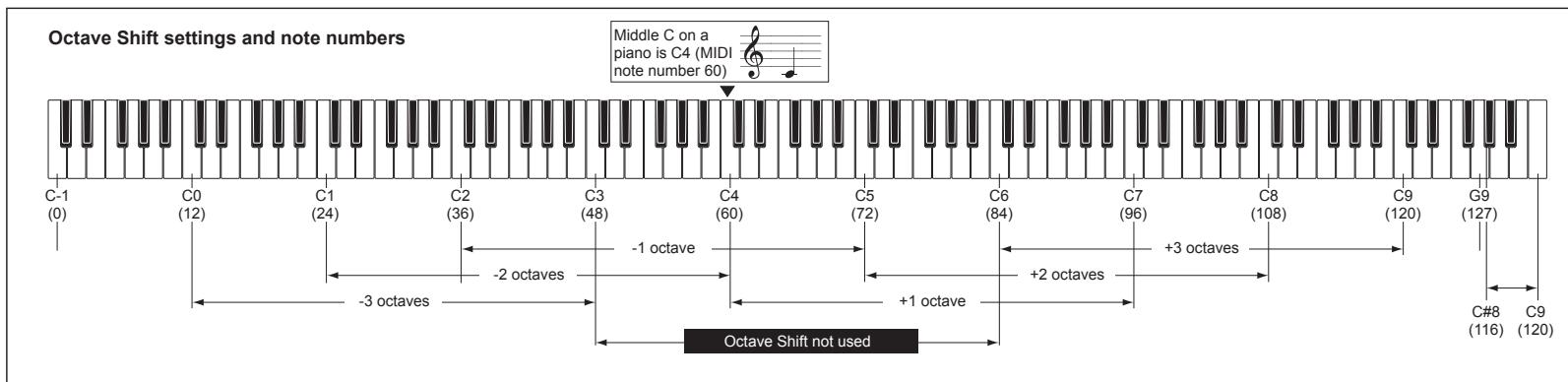

Using the knobs to modify the sound

When the [KNOB FUNCTION SELECT] dial is set to “ASSIGN,” “FILTER,” “AMP EG,” “EFFECT,” or “ARP,” you can use knobs [1]–[3] to control the performance edit functions. Try turning each knob, and hear the sound change in realtime.

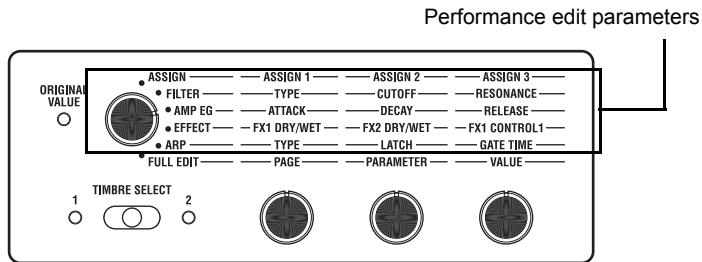

Using performance editing

1. Select a program.
2. Use the [KNOB FUNCTION SELECT] dial to choose the section that you want to edit.
Consider how the original program differs from the sound you have in mind, and then choose the appropriate parameters to edit.
NOTE Use the [TIMBRE SELECT] lever or the [VOCODER] button to select the part to edit.
3. While playing the keyboard, use knobs [1], [2], and [3] to modify the sound.
For example if you're editing a synth program and you choose “FILTER” in step 2, the three knobs will control the filter's TYPE, CUTOFF, and RESONANCE parameters as printed on the front panel.
Knob [1] will select the filter type of filter 1.
Knob [2] will change the cutoff frequency of filter 1.
Knob [3] will change the resonance of filter 1, adding a distinctive character to the sound.
NOTE You can save the sound you've modified using performance edit.

Some of the main parameters you can control using performance edit are described below.

CUTOFF

This adjusts the cutoff frequency of filter 1, varying the brightness of the sound. Normally, turning the knob toward the left will darken the sound, and turning the knob toward the right will brighten the sound.

RESONANCE

This adjusts the amount of resonance for filter 1, adding a distinctive character to the sound.

For an LPF (Low Pass Filter)

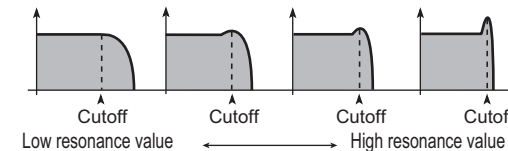

ATTACK

This adjusts the attack time of EG2 (the amp EG). It specifies the time from note-on (pressing a key) until the attack level is reached. This will vary the speed at which the EG2 sound begins. Normally, turning the knob toward the left will shorten the attack time, and turning it toward the right will lengthen the attack time.

RELEASE

This adjusts the release time of EG2 (the amp EG). It specifies the time from note-off (releasing a key) until the sound decays to silence. This will vary the EG2 release time. Normally, turning the knob toward the left will shorten the release time, and turning it toward the right will lengthen the release time.

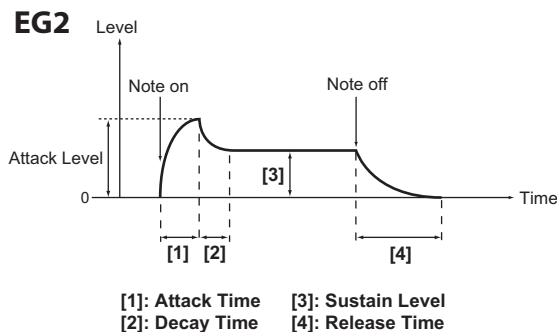

Performance editing when ASSIGN is selected

If the [KNOB FUNCTION SELECT] dial is set to "ASSIGN," the most useful parameters for the currently selected program will be assigned to the knobs.

NOTE You are free to change the parameters that are assigned to the knobs. For each program, you can freely assign a parameter to each knob [1]–[3] and use it to control the program. (→ p. 33 "KNOB")

Performance editing when EFFECT is selected

If the [KNOB FUNCTION SELECT] dial is set to "EFFECT," parameters for the effect used by the currently selected program will be assigned to the knobs.

Knob [1] (FX1 DRY/WET, knob [2] (FX2 DRY/WET)

These adjust the balance between the effect sound and direct sound of the FX1 and FX2 effects.

Turn the knob all the way to the left for a sound without any effect applied ("dry"), or all the way to the right for the maximum effect sound ("wet").

NOTE These knobs won't do anything if the FX TYPE of the selected program is set to "FX OFF." In this case, the display will indicate "INVALID."

Knob [3] (FX1 CONTROL 1)

This adjusts the parameter that's assigned to CTRL-1 (FX1 CONTROL 1) for the effect used by the currently selected program.

NOTE You are free to change the parameter that's assigned to this knob. Refer to page 63 "Controlling effect parameters."

NOTE This knob won't do anything if the FX TYPE of the selected program is set to "FX OFF." In this case, the display will indicate "INVALID."

4. Playing arpeggios

Using the arpeggiator

The arpeggiator is a function that automatically plays a broken chord (arpeggio) when you hold down a chord on the keyboard.

The **microKORG XL+**'s arpeggiator provides six arpeggio types, and allows you to change various aspects of the arpeggio, such as the duration (gate time) of the notes. It also provides a "step arpeggiator" that lets you specify the on/off status for up to eight steps, giving you a wide range of performance possibilities.

1. Select a program.

You can use the arpeggiator with both synth programs and vocoder programs, but in this example we'll select a synth program such as "A24: PRAY ARP" in order to try out this function.

2. Press the [ARP ON] button to make the LED light, turning the arpeggiator on.
3. Hold down a chord on the keyboard; an arpeggio will start playing.



When you hold down a chord, it will be sounded as shown at the right.
(TYPE: UP)

4. Use the [TEMPO] knob to adjust the tempo.

5. To stop the arpeggio, press the [ARP ON] button (the LED goes dark).

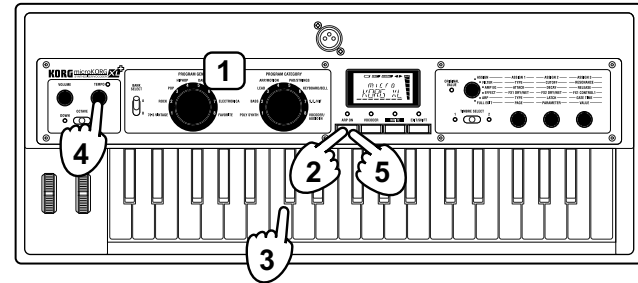

Editing the sound

1. How a program is organized

Before you start editing, you'll need to understand the basics of how the sounds are created. Once you understand how the **microKORG XL+**'s sounds are structured, you'll be able to freely create the sounds you want.

Synthesizer

As shown in the illustration, a synth program consists of timbres 1/2, master effects 1/2, and the arpeggiator.

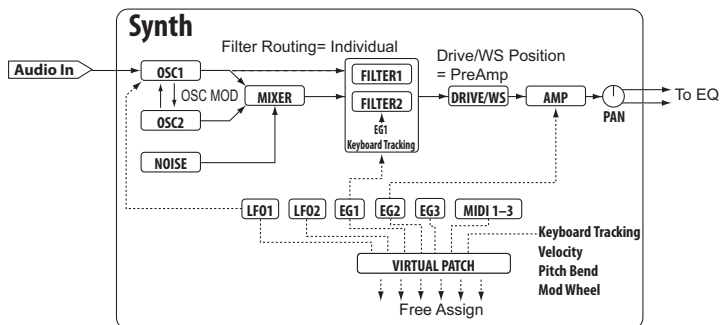
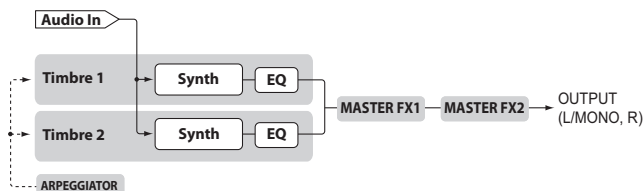

The three elements of sound: pitch, tone, and volume

Sound has three basic elements: pitch, tone, and volume. Just like the analog synthesizers of the past, the **microKORG XL+** analog modeling synthesizer provides “oscillator,” “filter,” and “amp” (amplifier) sections that control these three elements.

Edit the oscillator settings to change the pitch, the filter settings to change the tone, and the amp settings to change the volume.

Oscillator, filter, and amp

On the **microKORG XL+**, the oscillator settings are found in the OSC1 and OSC2 pages and the PITCH page. Use the PITCH page to specify the pitch of the basic waveform, and then select the waveforms in the OSC1 and OSC2 pages. The waveforms generated by this oscillator section are mixed together by the mixer. The filter settings are located in the FILTER page. On this page you can modify the tone by applying filters to the sound produced by the oscillator.

Finally, the amp parameters are located in the AMP page. On this page you can modify the volume.

You can create a basic program by editing the settings in these pages.

EG, LFO, keyboard tracking, virtual patch, and controllers

In addition to the way that it's affected by the oscillator, filter, and amp, a synthesizer sound can also change in various other ways; over the passage of time, according to the pitch you play, or in response to various performance gestures. These changes in the sound are controlled by modulators and controllers such as the EG (envelope generator), LFO (low frequency oscillator), keyboard tracking, virtual patch, and wheels such as [PITCH] and [MOD]. You can use these modulators and controllers to produce various changes in the basic sound of the program.

Take a look at the illustration that shows the structure of the **microKORG XL+**. Notice that the signal flows in the order of OSC → FILTER → AMP. You will also notice that these sections can be controlled by things such as EGs and LFOs.

As shown in the illustration, a synth program consists of timbres 1/2, effects, and the arpeggiator.

Timbres (TIMBRE 1/2)

Each timbre consists of an oscillator, filter, amp, EG, LFO, virtual patches, and equalizer. The **microKORG XL+** has two timbres, and you can combine these two timbres to create a richer-sounding program.

Oscillator (OSC1, OSC2, NOISE)

Oscillator 1 (OSC1) lets you choose from seven types of oscillator algorithm such as the sawtooth wave or square wave familiar from analog synthesizers, as well as formant wave, noise, and PCM/DWGS, and also lets you select the input signal from the AUDIO IN jack. You can also apply cross modulation, unison, or VPM (Variable Phase Modulation) to a basic analog synthesizer waveform such as sawtooth or square wave.

Oscillator 2 (OSC2) lets you choose a waveform from four types of oscillator algorithms such as sawtooth wave or square wave, and it can also be used as a modulation-type oscillator to create the sync modulation or ring modulation that is distinctive of analog synthesizers.

The noise generator (NOISE) produces white noise. You can use this to simulate breath noise in a wind instrument sound, or to produce sound effects.

Mixer (MIXER)

This section lets you adjust the volume level of oscillator 1 (OSC1), oscillator 2 (OSC2), and noise generator (NOISE), and sends the resulting mix to the filters (FILTER).

Filters (FILTER 1, FILTER 2)

The filter varies the brightness of the sound by removing or boosting certain portions of the frequency spectrum of the sound generated by the oscillator. Filter settings will have a large impact on the character of the sound. There are two filters for each timbre, and you can create a wide range of sounds by choosing from four routings (types of connection) for these filters. In addition, you can use envelope generator 1 (EG1) to vary the cutoff frequency of each filter over time.

Amp (AMP)

This section consists of the amp (AMP) and pan (PAN) settings. The amp specifies the volume, and the pan specifies the stereo position of the sound. You can also use envelope generator 2 (EG2) to vary the volume over time.

Drive/waveshaping (DRIVE/WS)

Drive and waveshaping both give the tone a hard-edged character. Adjusting the cutoff or resonance of the filter can produce significant changes.

Envelope generators (EG1, EG2, EG3)

An envelope generator applies time-variant change to parameters that make up the sound. Each envelope generator defines the “shape” of the time-variant change using four parameters: attack time, decay time, sustain level, and release time. EG1 is assigned to control the filter cutoff frequency, and EG2 is assigned to control the amp volume. You are free to assign EG3 to any desired parameter by using a virtual patch. EG1 and EG2 can also be used with a virtual patch as an envelope source for other parameters.

LFOs (LFO1, LFO2)

An LFO (Low Frequency Oscillator) applies cyclic change to parameters that make up the sound. Each timbre has two LFOs, each giving you a choice of five waveforms. For some waveforms that can be selected for oscillator 1 (OSC1), LFO1 is assigned as “control 2” (OSC1 Control 2), and LFO2 is assigned as a pitch modulation source via the modulation wheel. You can also use a virtual patch to assign the LFO as a modulation source for other parameters.

Virtual patch (VIRTUAL PATCH)

The virtual patch functionality lets you use not only EG or LFO but also sources such as velocity (keyboard playing strength) and keyboard tracking (the keyboard region that you play) as modulation sources to control the parameters that make up the sound. This gives you a great deal of freedom in creating original sounds. For each timbre, you can create virtual patch settings for six parameters.

Equalizer (EQ)

Each timbre contains a two-band EQ. You can use this to adjust the tonal balance between the two timbres; for example you might accentuate a sound that would otherwise be lost in the mix, or to restrain a sound that stands out too much.

Master effects (MASTER FX)

Each program contains two master effects. By applying these effects to the final mixed sound of the two timbres, you can add the finishing touch to the overall program.

Arpeggiator (ARPEGGIATOR)

The arpeggiator automatically generates an arpeggio (broken chord) when you hold down a chord on the keyboard. For programs that use two timbres, you can apply the arpeggiator to either or both timbres. This is a step arpeggiator with six arpeggio types.

Vocoder

A vocoder analyzes the frequency characteristics of one signal called the “modulator” (such as a human voice input via a mic) and applies these characteristics to a filter that is processing a different signal called the “carrier” (such as an oscillator waveform), thus producing distinctive effects such as an instrument that appears to be talking.

The **microKORG XL+** contains a sixteen-band vocoder that can simulate not only the classic vocoder sounds of the past but also create original vocoder sounds where the tonal character or the level of each band can be controlled.

As shown in the illustration below, the vocoder consists of the carrier (the signal being modified), the modulator (the signal that controls the modifying), and the vocoder section itself.

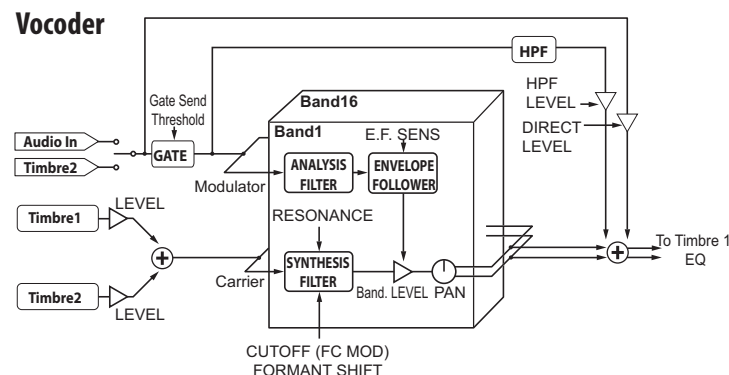
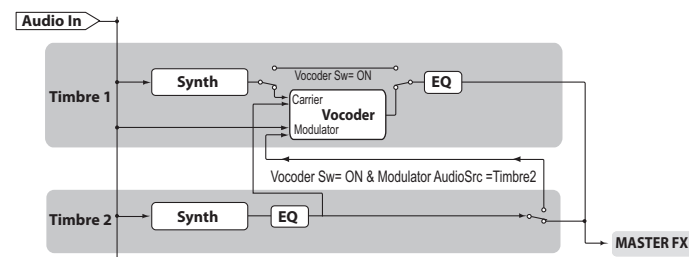

Vocoder section (VOCODER)

This consists of two sets of sixteen bandpass filters (the analysis filter and the synthesis filter) and an envelope follower. The audio signal input to the modulator is sent to sixteen filters (the analysis filter), and an envelope follower will detect the volume envelope (time-variant change) of each frequency band.

The carrier signal is sent to a separate set of sixteen filters (the synthesis filter), and the envelope detected from the analysis filter is used to control the volume of each band in the synthesis filter, thus varying the tonal character of the carrier signal and producing the impression that the carrier signal is talking. It is also possible to shift the frequencies of the carrier bandpass filter. This allows you to raise or lower the frequency response while preserving the character of the modulator, creating dramatic changes in the sound.

Editing the sound

Carrier (CARRIER)

The most suitable choice as a carrier is a waveform that contains large numbers of overtones, such as a sawtooth wave or pulse wave. The output of timbres 1 and 2 is mixed and used as the carrier.

Modulator (MODULATOR)

A human voice is typically used as the modulator, but you can also obtain unique results by using rhythm sounds or another type of waveform. The **microKORG XL+** allows you to select either an external input such as mic or rhythm (AUDIO IN) or timbre 2 as the modulator. If you've selected timbre 2, the output of the timbre 2 EQ will be input to the modulator.

2. Basic editing procedure

There are two ways to edit sounds on the **microKORG XL+**.

- You can select a program that's close to the sound you want, and create the desired program by making the necessary changes.
- You can start editing the program from scratch (an initialized state). Choose a method, and get started creating and playing your own sounds!

Editing a program

Performance editing

1. Select the program that you want to edit.
2. Use the [KNOB FUNCTION SELECT] dial to choose the section that you want to edit.

Take a moment to consider how the original program is different than what you have in mind, and choose the appropriate parameter to edit.

NOTE Use the [TIMBRE SELECT] lever or the [VOCODER] button to select the part that you want to edit.

3. Use knobs [1], [2], and [3] to edit the values of the parameters assigned to each knob.
4. Repeat steps 2 and 3 as needed to create the desired sound.
5. Write your edited program.
→ p. 31 "Saving (Writing)"

 If you select another program or turn off the power before you've written your edited program, the changes you made will be lost.

If you want to create a program from scratch

If you want to create a program from scratch, start by initializing to enter program.

→ p. 28 "Initializing a program"

NOTE If you're creating a program from scratch using Full Edit mode, you can take advantage of the fact that pages are organized in the appropriate order; simply proceed by turning knob [1] to step through the pages.

3. Full Edit mode

If you set the [KNOB FUNCTION SELECT] dial to "FULL EDIT," all of the parameters will be available for editing.

NOTE This includes the MIDI-related settings (GLOBAL).

Editing in Full Edit mode

1. Select the program that you want to edit.
2. Set the [KNOB FUNCTION SELECT] dial to FULL EDIT.
3. Use knobs [1] and [2] to select the parameter that you want to edit, and knob [3] to edit the value.

Use knob [1] to select the page in which to edit.

Use knob [2] to select a parameter on that page.

Use knob [3] to edit the value of the selected parameter.



If you select another program or turn off the power before you've written your edited program, the changes you made will be lost.

About the display in Full Edit mode

When you turn knob [1] to select the OSC1 page, the upper line of the display will indicate the name of the page, and the lower line will indicate the name of a parameter.

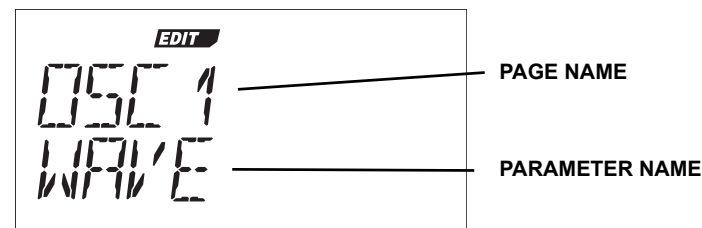

Now when you turn knob [2], the display will change; the upper line will show the parameter name, and the lower line will show the value that changes when you turn knob [3].

The illustration below is an example of when you've selected the OSC MODE parameter WAVEFORM.

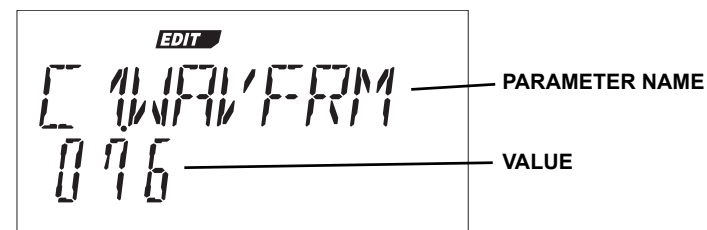

How to edit parameters

INC/DEC function

If you want to make fine changes to the value of a parameter, hold down the [EXIT/SHIFT] button and operate the OCTAVE lever to increment or decrement the value.

For example if you're specifying a numerical value, move the lever toward UP to increment the value by one, or toward DOWN to decrement it.

If the parameter value does not change when you turn the knob

In some cases when you've used the [KNOB FUNCTION SELECT] dial to choose a section to edit, turning knobs [1]–[3] may not change the value of the parameter.

This is because the Full Edit mode GLOBAL page "KNOB.MODE" parameter is set to "CATCH." With this setting, the actual value of the parameter you're editing (the value shown in the display) will not change unless it matches the position of the knob.

If "KNOB.MODE" is set to "CATCH," the knob position and the value will be linked only when the knob position reaches the actual value. This prevents the unnatural change that might be produced by a sudden change in the value.

If the Full Edit mode GLOBAL page "KNOB.MODE" parameter is set to "JUMP," the actual value will immediately jump to the knob position the instant you move the knob.

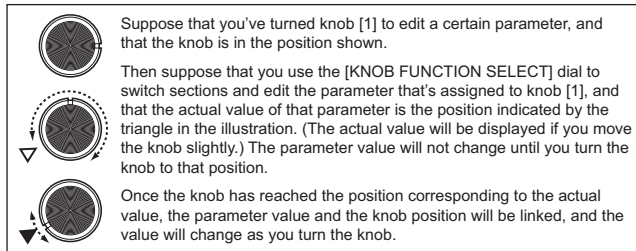

If "KNOB MODE" is set to CATCH

Suppose that knob [1] is in the position shown in the illustration.

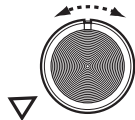

If the actual value of the parameter was at the position shown by the triangle, turning the knob slightly will make a "◀" symbol appear in the display. This symbol means that the actual value is toward the left of the position indicated by the knob.

Conversely, if the actual value is toward the right of the knob position, a "▶" symbol will appear in the display.

Restoring an edited program value to its original setting

When you set a value to the same value stored in the original preset program or saved program, the ORIGINAL VALUE LED will light.

After editing a value, you can restore that value to its original setting by turning knobs [1]–[3] to the value that makes the ORIGINAL VALUE LED light-up. If you're in Full Edit mode, the ORIGINAL VALUE LED will light-up when the setting of knob [3] matches the original value.

If you've been editing, but then select a different program and then re-select the program you had been editing, the values will return to the preset program or stored program value.

NOTE Settings affecting the entire **microKORG XL+** or MIDI-related settings (GLOBAL) are made using the same procedure as when editing a program; use the [KNOB FUNCTION SELECT] dial to select the Full Edit mode section, and then use the knobs to edit the values. These settings will also revert to their un-edited state if you turn off the power, so you must Write them if you want to keep the changes you make.

Editing the two timbres

You can use two timbres in a program.

The parameters of each timbre are organized into the NAME–EQ pages. To edit these parameters, you must first select the timbre that you want to edit (the [TIMBRE 1] or [TIMBRE 2] LED will light).

NOTE The COMMON page "VOIC.MODE" parameter affects the entire program.

Using two timbres (Layer)

If you're using two timbres, you can choose one of three modes in which to use them. Here we'll set the "VOIC.MODE" to LAYER.

With LAYER mode, both timbres will sound simultaneously when you play a key. For details on the other modes, refer to page 32 "VOIC.MODE".

1. Use the [KNOB FUNCTION SELECT] dial to select "FULL EDIT."
2. Use knob [1] to select the COMMON page, use knob [2] to select "VOIC. MODE," and use knob [3] to select LAYER.

Selecting the timbre to edit

When you edit a program that uses two timbres, you'll need to select which timbre you want to edit. Use the [TIMBRE SELECT] lever to choose which timbre that you want to edit.

The LED of the selected timbre will light-up, and that timbre will be the one affected by your editing.

NOTE The TIMBRE SELECT LED won't light if the COMMON page "VO-IC.MODE" parameter is SINGLE. The LED of the timbre being edited will light if you've selected LAYER, SPLIT, or MULTI as the voice mode (→ p. 32).

Editing the vocoder

You'll use the VC FILT–VC BAND pages to edit the parameters of the sixteen bandpass filters (analysis filter and synthesis filter) and the envelope follower.

Carrier

The best choice for the carrier is a waveform that contains a large number of overtones, such as a sawtooth wave or fixed-width pulse wave. You can edit these parameters in the VC CARRI page.

NOTE If you want to input a sawtooth wave as the carrier, first edit timbre 1 so that the OSC1 page "WAVE" parameter is set to SAW; then in the vocoder settings, use the VC CARRI page "TMBR1.LVL" parameter to adjust the input level of timbre 1.

Modulator

A human voice is typically used as the modulator, but you can also obtain interesting results by using rhythm sounds or some other audio source. As the modulator, the **microKORG XL+** lets you choose either an external input such as mic or rhythm (AUDIO IN) or timbre 2. You can edit these parameters in the VC.MOD page.

Selecting the vocoder for editing

The process of editing the vocoder settings is essentially the same as when editing a timbre, but you'll need to turn on the vocoder function and select it for editing.

1. Select a synth program.
2. Press the [VOCODER] button.

The LED above the [VOCODER] button will light-up, and the vocoder function will turn on. The vocoder will also be selected as the object of your editing.

3. Set the [KNOB FUNCTION SELECT] dial to "FULL EDIT."

4. Use knob [1] to select one of the VC CARRI–VC BAND pages, and then use knobs [2] and [3] to edit the vocoder parameters.

When the vocoder is the selected object for editing, knob [1] will select vocoder parameter pages.

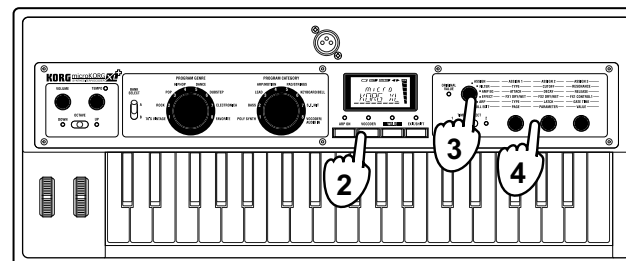

NOTE If you press the [VOCODER] button to make the LED light, set the [KNOB FUNCTION SELECT] dial to Full Edit and turn knob [1] to raise the VC AMP page "DIRCT.LVL" parameter, the input audio will be output directly. Raise this value if you want to hear the input audio while you make adjustments.

NOTE If you have difficulty hearing the effect, press the [VOCODER] button to make the LED light, set the [KNOB FUNCTION SELECT] dial to Full Edit, and turn knob [1] to adjust the VC CARRI page "TMBR1.LVL" parameter or the VC AMP page "VC LEVEL" parameter.

Processing an external audio input

You can use the filter, amp, EGs, and LFOs etc. to modify a signal from an external synthesizer, rhythm machine, or audio device in the same ways that you modify an oscillator waveform.

NOTE Before you connect an external device, power-off the **microKORG XL+** and any external devices including amps or powered speakers, and make connections before you turn the power on again.

NOTE You can use the external input as the carrier of the vocoder.

1. Set the [KNOB FUNCTION SELECT] dial to "FULL EDIT."
2. Use knob [1] to select the OSC1 page, knob [2] to select "WAVE," and knob [3] to select "AUDIO IN."

3. Connect an audio signal from your external device to the input, and adjust the AUDIO IN [LEVEL] knob as high as possible without allowing the “CLIP” indicator to appear in the display.
4. Play the keyboard while listening to the sound.
5. Edit the filter, amp, EG, LFO, and effect settings to modify the sound.



Pitch-related parameters will not affect the sound from the AUDIO IN jack.

Editing the arpeggiator

The **microKORG XL+**'s arpeggiator provides six arpeggio types. You can adjust the duration (gate time) and the spacing of the notes generated by the arpeggiator. These settings are located in the ARP page. There's also a “step arpeggiator” function that lets you specify the note on/off status for each of up to eight steps, giving you a wide range of performance possibilities.

Selecting the timbre(s) to arpeggiate

For a program that uses two timbres, you can select the timbre(s) that will be played by the arpeggiator.

This is specified by the ARP page “ASSIGN” parameter. You can make the arpeggiator play both timbres, or just one of them.

Synchronizing the arpeggiator

Synchronizing LFO1/2 frequency or effect delay time to the arpeggio

You can synchronize the frequency of LFO1 or LFO2 to the arpeggio tempo. This lets you apply modulation that's synchronized with the tempo. This also gives you the ability to specify an effect's delay time as a multiple of the tempo so that the delay time will follow even if you change the arpeggio tempo.

You can also synchronize the **microKORG XL+**'s arpeggiator to an external MIDI sequencer, so that the LFO1/2 frequency or the delay time will be controlled from your external sequencer.

Modifying the arpeggio

You can modify the arpeggio by turning each arpeggio step on/off. This is called the “step arpeggiator” function.

Using the step arpeggiator to modify the arpeggio

1. After selecting Full Edit mode, use knob [1] to select the ARP.STEP page.
2. Use knob [2] to select the arpeggiator step.

3. Use knob [3] to turn the selected step on/off.

In the display, enabled steps are indicated as “O” (on). If you turn knob [3] to change the indication to “-” (off), that step will be a rest.

TYPE: UP
LAST STEP: 8



NOTE The number of available steps is specified by the ARP page “LAST.STEP” parameter (→ p. 52).

4. About the Global settings

The GLOBAL parameters are settings that apply to the entire **microKORG XL+**. For example, you can individually adjust the pitch of each program, but the pitch settings in this GLOBAL page (“MST TUNE” and “TRANS-POS”) will affect the pitch of all programs.

If you’re playing together with other instruments, set “MST TUNE” to match the **microKORG XL+**’s pitch with the other instruments, and use “TRANS-POS” if you need to transpose the song you’re playing. When you use multiple programs within a single song, it’s convenient to change just the GLOBAL parameter settings instead of changing the pitch of each program. For details, refer to page 57 “5.Global parameters”.

 If you want to keep the changes you make to these parameters, you must Write them (→ p. 31 “Saving global data”).

5. Other functions

Initializing a program

Here's how to initialize the settings of the currently selected program.

1. In Full Edit mode, turn knob [1] to select "INIT.PROG."
2. Turn knob [2] to make the display indicate "SURE Y/N."
Here you can select either "YES" or "NO."
3. To initialize, select "YES" and press the [WRITE] button.
The program will be initialized, and the display will indicate "COMPLETE."

NOTE If you decide not to initialize, press the [EXIT/SHIFT] button.

Copying a timbre

Here's how to copy timbre settings from another program to the timbre of the currently selected program.

1. In Full Edit mode, turn knob [1] to select "COPY.TMBR."
2. Turn knob [2]; the left side of the display will show the copy-source program number, the middle will show the copy-source timbre, and the right will show the copy-destination timbre.
3. Use knob [2] to move the cursor below the program number, and then use knob [3] to select the copy-source program.
4. Use knob [2] to move the cursor below the timbre, and then use knob [3] to select the copy-source timbre.
5. Use the [TIMBRE SELECT] lever to select the copy-destination timbre.
6. To execute the copy, press the [WRITE] button.

The copy will be executed, and the display will indicate "COMPLETE."

NOTE If "VOIC.MODE" is "SINGLE," you can't select "TIMBRE2" as the copy-destination.

NOTE If you decide not to execute the copy, press the [EXIT/SHIFT] button.

Transmitting programs and other data (Data Dump)

Program data and global data can be transmitted from the **microKORG XL+** as MIDI exclusive data. The action of transmitting MIDI exclusive data to an external MIDI device is called a "data dump."

By performing a data dump you can store various types of data on an external MIDI device, or change the sounds or settings of another **microKORG XL+** unit.

NOTE If the **microKORG XL+** receives a dump request from an external device, it will execute a data dump according to the type of request that it received.

NOTE If you want data dumps to be received, turn the GLOBAL page "PROTECT" parameter off, and set the MIDI FLT page "SYS EX" parameter to ENABLE. If this is set to DISABLE, data dumps cannot be received.

NOTE The "MIDI Implementation" including details on the MIDI exclusive format can be downloaded from the Korg website.



Do not touch the **microKORG XL+**'s knobs or keyboard while data is being transmitted or received. Never turn off the power during this time.



Some MIDI interface devices may be unable to transmit or receive the **microKORG XL+**'s MIDI exclusive messages.

Procedure for transmission

Connect the **microKORG XL+**'s MIDI OUT connector to the MIDI IN of the device that will be receiving the MIDI data dump, and set both devices to the same MIDI channel. If you want to use a USB connection, connect the **microKORG XL+** to your computer via a USB cable.

NOTE For details on connections, refer to page 80 "1. Using the microKORG XL+ with other MIDI devices (MIDI)".

1. In Full Edit mode, use knob [1] to select the "MIDI.DUMP" page.
2. Use knob [2] to select the data that you want to dump.
 - 1 PROG:** Only the data for the currently selected program will be transmitted (the parameters in the NAME-VC BAND pages, and the settings of the front panel buttons and knobs).
 - ALL PROG:** All program data will be transmitted.
 - GLOBAL:** Global data will be transmitted (the parameters of the GLOBAL-USR.SCALE pages).
 - ALL DATA:** All program data and global data will be transmitted.

3. Press [WRITE] button to execute the data dump.

The data dump will be executed. When the dump is completed, the display will indicate "COMPLETE."

NOTE For details on the contents of program data and global data, refer to the sections "Saving a program" and "Saving global data" in "Saving (Writing)" (→ p. 31).

NOTE For details on the size of each data dump and the time required, refer to the table on this page.

Procedure for reception

Here's how data saved on a connected MIDI data filer or computer can be sent back to the **microKORG XL+**, or data received from another **microKORG XL+** unit.

1. Connect the **microKORG XL+**'s MIDI IN connector to the MIDI OUT of the device that will be transmitting the MIDI data dump.

If you're using a USB connection, connect the **microKORG XL+** to your computer via a USB cable.

2. Set both the transmitting device and the **microKORG XL+** to the same MIDI channel.

If you want the **microKORG XL+** to receive data that was previously transmitted to an external MIDI device, set the **microKORG XL+** to the same MIDI channel as when it transmitted the data.

3. In the MIDI FLT page, set "SYS EX" to ENABLE (→ p. 60), and turn the GLOBAL page "PROTECT" parameter OFF (→ p. 58).
4. Transmit the data from your MIDI data filer or other device. For details on how to transmit data, please refer to the owner's manual of the device you're using.

Dump data	Data size	Time required
1 Prog	402 Bytes	Less than 1 second
All Prog	51,712 Bytes	Approx. 3'15"
Global	121 Bytes	Less than 1 second
All Data	51,833 Bytes	Approx. 3'15"

Restoring the factory settings

Here's how to restore the **microKORG XL+**'s programs and global data settings to their factory-set condition.

The factory settings are called the "preload data."



When you execute the Preload operation, the **microKORG XL+**'s data will be rewritten to the factory-set condition. Before you continue, make sure that it's OK to rewrite the data.



Do not touch the **microKORG XL+**'s knobs or keyboard while the Preload operation is in progress. Never turn off the power during this operation.

NOTE

You can't execute the Preload operation if Write Protect is turned on. You must turn off Write Protect before you execute this.

1. In Full Edit mode, turn knob [1] to select "PRELOAD."

2. Use knob [2] to select the desired type of preload data.

1 PROG: Only the data for the currently selected program will be loaded (the parameters of the NAME-VC BANK pages and the settings of the front panel buttons and knobs).

ALL PROG: All program data will be loaded.

GLOBAL: Global data will be loaded (the parameters of the GLOBAL-USR.SCALE pages).

ALL DATA: All program data and global data will be loaded.

3. Press the [WRITE] button to execute the operation.

The preload data will be loaded, and the display will indicate "COMPLETE."

NOTE If you decide not to execute, press the [EXIT/SHIFT] button.

Saving (Writing)

1. Saving the settings you've edited

If you've edited a program and would like to use that edited program again in the future, you'll need to save (write) it. Likewise, if you've edited settings in the GLOBAL-USR.SCALE pages, the changes you made will be lost if you turn off the power before saving (writing) them.

Be sure to save (write) any edited settings that you want to use again.

 Any changes that you make by editing a program will be lost if you turn off the power or switch to a different program before saving (writing).

 Never turn off the power while data is being written. Doing so may destroy the data.

Saving a program

The settings that are saved

The following items of the selected program will be saved.

- All parameters of the NAME-VC BAND pages
- ARPEGGIATOR [ARP ON] button
- OCTAVE [DOWN][UP]
- PROGRAM NAME
- KNOB ASSIGN

1. Press the [WRITE] button.

Verify that the display indicates "PROGRAM."

NOTE If the display indicates "GLOBAL" when you press the [WRITE] button, the Write operation will apply to the global parameters. Use knob [1] to select "PROGRAM."

2. Press the [WRITE] button once again.

3. Use knob [1] to select the writing-destination program number.

4. Press the [WRITE] button to write the data.

The display will indicate "COMPLETE," at this point the Write operation will be completed, and the **microKORG XL+** will return to its normal state. If you decide to cancel the operation, press the [EXIT/SHIFT] button.

NOTE If the display indicates "ERROR" when you press the [WRITE] button, Write Protect is turned on (program data cannot be written). Press the [EXIT/SHIFT] button to cancel the Write operation, and turn off Write Protect.

Saving global data

The settings that are saved

- All parameters of the GLOBAL-USR.SCALE pages

1. Press the [WRITE] button.

If the display indicates "PROGRAM" (as the data to be saved), use knob [1] to select "GLOBAL."

2. Press the [WRITE] button to exit the Write operation.

The display will indicate "COMPLETE," at this point the Write operation will be completed, and the **microKORG XL+** will return to its normal state. If you decide to cancel the operation, press the [EXIT/SHIFT] button.

Parameter Guide

1. Timbre parameters

NAME

The **microKORG XL+** lets you assign a name of up to eight characters to each program. In Play mode, the display will show the program number and program name.

To edit the program name

1. Use knob [1] to select the NAME page.
2. Use knob [2] to move the cursor to the character that you want to change.
3. Use knob [3] to specify the desired character.
4. Repeat steps 2–3.

 The edited program name will be lost if you turn off the power or switch programs before writing. If you want to keep the edited program name, be sure to write the program (→ p. 31).

COMMON

Here you can make settings that apply to the entire program and settings that specify how the timbres will sound. You can choose whether to use only a single timbre (SINGLE), or how to use two timbres (LAYER, SPLIT, MULTI). You can also specify whether the timbre selected by the TIMBRE SELECT lever will play monophonically or polyphonically, and specify how retriggering will occur.

NOTE If you simultaneously play more keys than the maximum number of voices that can be sounded according to these settings, the last-played keys will take priority.

VOIC.MODE..... [SINGLE, LAYER, SPLIT, MULTI]

This parameter determines how many timbres a program will use, and how those timbres will be allocated.

SINGLE: Only one timbre will be used.

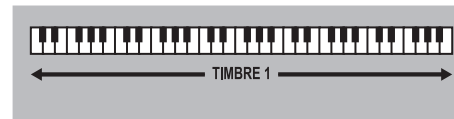

LAYER: Two timbres will be used. When you play the keyboard, both timbres will sound simultaneously. You can edit each timbre individually.

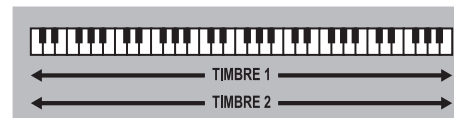

SPLIT: Two timbres will be used. You can specify a range of notes for each timbre, and play each timbre from a different area of the keyboard. Each timbre can be edited separately.

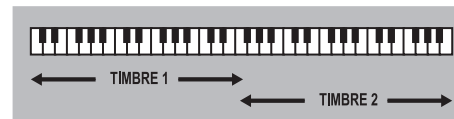

MULTI: Two timbres will be used. This mode is mainly used when playing the **microKORG XL+** from an external MIDI device. Each timbre can be edited separately.



SPLIT.KEY..... [C-1...G9]

This parameter will appear if “VOIC.MODE” is set to “SPLIT.” It specifies the range in which each timbre will sound.

Notes below the note number you specify will be sounded by timbre 1, and notes above (and including) that number will be sounded by timbre 2.

T2MIDI.CH (Timbre 2 MIDI channel) [GLOBAL, 01...16]

When the "VOIC.MODE" is set to either Layer or Multi, this parameter can be used to set the MIDI channel for timbre 2.
 If you choose Global, the MIDI channel of timbre 2 will match the global MIDI channel.

NOTE Timbre1 will always be set to the Global MIDI channel. You can specify the timbre1 MIDI channel by setting the MIDI page parameter "MIDI CH."

ASSIGN [MONO1, MONO2, POLY]

This parameter specifies how notes will be articulated from the keyboard (or MIDI source).

MONO1: The timbre will play monophonically. If you continue holding down the key that you first pressed, the EG will not retrigger when you play the second and subsequent keys. Use this setting when you want to play legato.

MONO2: The timbre will play monophonically. The EG will be retriggered each time you press a key.

POLY: The program will play polyphonically, allowing you to play chords. The maximum polyphony is eight voices.

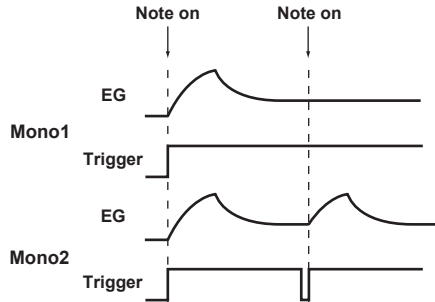

SCALE[EQUAL...USER]

Selects the type of scale that the current program will use. You can choose one of ten different scale types.

EQUAL	Equal temperament, which is the most commonly used scale. Every semitone is spaced an equal pitch distance from the next.
MAJOR	Pure major scale. Major chords in the key specified by "SCALE.KEY" will be completely harmonious.
MINOR	Pure minor scale. Minor chords in the key specified by "SCALE.KEY" will be completely harmonious.
ARABIC	Arabic scale. It includes the quarter-tone scale characteristic of Arabian music.
PYTHA	Pythagorean scale, a scale based on ancient Greek musical theory. It is particularly effective when playing melodies.
WERCK	Werckmeister scale, an equal tempered scale used in the late Baroque period.
KIRN	Kirnberger scale, created in the 18th century, and used mainly for tuning harpsichords.
SLENDRO	Slendro scale, an Indonesian gamelan scale that divides the octave into five notes. If the "SCALE.KEY" is C, use the C, D, F, G, and A keys.
PELOG	Pelog scale, an Indonesian gamelan scale that divides the octave into seven notes. If the "SCALE.KEY" is C, use the C, D, E, F, G, A, and B keys.
USER	The scale you created in the Global mode USR.SCALE page. (→ p. 61)

SCALE.KEY[C...B]

Specifies the tonic ("key" or "root note") for the scale you selected in "SCALE."

Knob

Here you can assign the parameter that will be controlled by knobs [1]–[3] when you set the [Knob Function Select] dial to Assign.

You can make assignments for knobs [1]–[3] independently for timbre 1 and timbre 2; the knobs will control the timbre that’s selected by the [TIMBRE SELECT] lever.

NOTE With the factory settings, suitable parameters are already assigned to the knobs.

ASSIGN [ASSIGN1...ASSIGN3]

Select the knob to which you want to assign a parameter.

ASSIGN1: Assign a parameter to knob [1].

ASSIGN2: Assign a parameter to knob [2].

ASSIGN3: Assign a parameter to knob [3].

Parameter

Select the parameter assigned to the knob.

Display	Parameter Name
-----	No Assign
PORTMNT0	Portamento
OSC1 C1	OSC1 Control 1
OSC1 C2	OSC1 Control 2
OSC2.SEMI	OSC2 Semitone
OSC2.TUNE	OSC 2 Tune
OSC1 LVL	OSC 1 Level
OSC2 LVL	OSC 2 Level
NOISE.LVL	Noise Level
CUTOFF1	Filter 1 Cutoff
RESO1	Filter 1 Resonance
FILT1.BAL	Filter 1 Balance
EG1 INT1	Filter 1 EG 1 Intensity
CUTOFF2	Filter 2 Cutoff
RESO2	Filter 2 Resonance
EG1 INT2	Filter 2 EG 1 Intensity

LEVEL	Level
PANPOT	Panpot
WS DEPTH	Wave Shape Depth
ATTACK1	Attack Time EG 1
DECAY1	Decay Time EG 1
SUSTAIN1	Sustain Level EG 1
RELEASE1	Release Time EG 1
ATTACK2	Attack Time EG 2
DECAY2	Decay Time EG 2
SUSTAIN2	Sustain Level EG 2
RELEASE2	Release Time EG 2
LFO1.FREQ/LFO1.NOTE	LFO 1 Frequency/Sync Note
LFO2.FREQ/LFO2.NOTE	LFO 2 Frequency/Sync Note
P.INT1	Virtual Patch Intensity 1
P.INT2	Virtual Patch Intensity 2
P.INT3	Virtual Patch Intensity 3
P.INT4	Virtual Patch Intensity 4
P.INT5	Virtual Patch Intensity 5
P.INT6	Virtual Patch Intensity 6
HI.EQ.GAIN	High EQ Frequency
LO.EQ.GAIN	Low EQ Frequency
FX1 D/W	FX 1 Dry/Wet
FX1.CTRL1	FX 1 Control 1
FX1.CTRL2	FX 1 Control 2
FX2 D/W	FX 2 Dry/Wet
FX2.CTRL1	FX 2 Control 1
FX2.CTRL2	FX 2 Control 2

GATE.TIME	Arpeggiator Gate Time
OCT.RANGE	Arpeggiator Octave Range
ARP.SWING	Arpeggiator Swing
VC T1.LVL	Vocoder Timbre 1 Level
VC T2.LVL	Vocoder Timbre 2 Level
VC.HPF.LVL	Vocoder HPF Level
VC.FC.OFST	Vocoder Fc Offset
VC RESO	Vocoder Resonance
VC.EF.SENS	Vocoder E.F.Sens
VC.FC.MINT	Vocoder Fc Modulation Intensity
VC.DIR.LVL	Vocoder Direct Level
VC LEVEL	Vocoder Level

UNISON

Here you can adjust settings for the Unison function which “stacks” voices at the same pitch to create a richer sound.

MODE [OFF, 2 VOICE, 3 VOICE, 4 VOICE]

When the Unison Switch is turned on, you can specify the number of voices that will be stacked.

OFF: Unison is off.

2 VOICE: Unison is on; two voices are stacked.

3 VOICE: Unison is on; three voices are stacked.

4 VOICE: Unison is on; four voices are stacked.

NOTE Depending on other voice-related settings, the number of voices you specify here may not actually be sounded.

NOTE Turning on the Unison function will limit the available polyphony.

DETUNE (Unison Detune) [0...99]

This parameter is available when Unison is on (i.e., if “MODE” is 2–4 Voice). It specifies (in units of cents) the amount of detuning that will occur between the stacked voices. Regardless of how many voices are stacked, this parameter will always specify the total range of detuning.

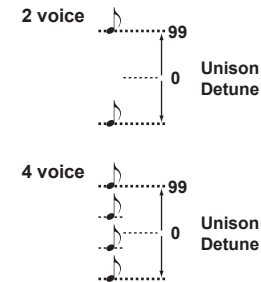

SPREAD (Unison Spread) [000...127]

This parameter is available when Unison is on (i.e., if “MODE” is 2–4 Voice). It controls the width of the stereo spread (panning) of the stacked voices. The number of voices specified by “MODE” will be panned apart at equal spacing according to this setting.

PITCH

Here you can adjust settings that affect the pitch of the oscillators. These settings are common to oscillators 1 and 2. Set the transpose and tuning parameters to obtain the desired pitch.

Here you can also specify the amount of pitch change that is produced by the [PITCH] wheel (pitch bend wheel) and [MOD] wheel (modulation wheel).

ANLG.TUNE (Analog Tune) [000...127]

By adding a slight randomness to the pitch of each note as it is played, this parameter can simulate the pitch instability and oscillator “drift” that was characteristic of vintage analog synthesizers. Higher settings will produce greater variations in pitch.

TRANSPOS (Transpose)..... [-48...+48]

Adjusts the pitch of the oscillators in semitone steps. The range is four octaves upward or downward.

NOTE This setting is related to the pitch of the oscillators themselves; this is not the same as the OCTAVE [UP], [DOWN] buttons on the front panel that change the range of notes available on the keyboard.

DETUNE [-50...50]

Adjusts the pitch of the oscillator in one-cent steps.

VIB INT (Vibrato Intensity) [-2400...+2400]

Specifies the depth of vibrato that will be applied when you move the [MOD] wheel all the way up.

NOTE You can produce a vibrato effect by using LFO2 to modulate the oscillator pitch, causing it to move up and down.

P.BEND (Pitch Bend) [-12...+12]

Specifies the range of the [PITCH] wheel in semitones This value specifies the amount of change that will occur when you move the pitch wheel all the way up or all the way down.

PORTMNT0 (Portamento)..... [000...127]

Portamento is a smooth change in pitch from one note to another. This parameter specifies the speed of the portamento effect. With a setting of 000, there will be no portamento effect. Increasing the value will lengthen the amount of time it takes for the portamento effect to transition from one note to the next.

OSC1 (Oscillator 1)

Oscillators generate the basic waveform. Each timbre has two oscillators. On this page you can make settings for oscillator 1. Use knob [2] to select the parameter that you want to edit, and knob [3] to edit the value.

WAVE (Waveform Select).....

[SAW, PULSE, TRIANGLE, SINE, FORMANT, NOISE, PCM/DWGS, AUDIO IN]

Selects the waveform for oscillator 1. The Saw, Pulse (square), Triangle and Sine are traditional waves associated with analog synthesizers.

SAW	A sawtooth wave.
PULSE	A pulse wave.
TRIANGLE	A triangle wave.
SINE	A sine wave.
FORMANT	A formant wave with tonal characteristics similar to that of a human voice.
NOISE	Generates noise.
PCM /DWGS	PCM/DWGS waveforms from acoustic instruments and digital synthesizers.
AUDIO IN	The audio signal received at the AUDIO IN [LINE] jack or AUDIO IN [MIC] jack will be used instead of the oscillator. NOTE Pitch-related parameters will not affect the signal received from the AUDIO IN [LINE] jack or [MIC] jack.

OSC MOD (Oscillator 1 Modulation Type)

.....[WAVEFORM, CROSS, UNISON, VPM]

Selects the type of modulation being applied to oscillator 1.

NOTE The maximum number of playable voices may change depending on the combination of “Wave” and “OSC MOD” settings.

WAVEFORM (Waveform Modulation): Use “Control1” to modify the shape of the waveform.

CROSS (Cross Modulation): Cross Modulation uses the output waveform of oscillator 2 (the modulator) to modulate the frequency of oscillator 1 (the carrier) at high speed to produce a modulated sound. The waveform selected by “WAVE” will be the carrier.

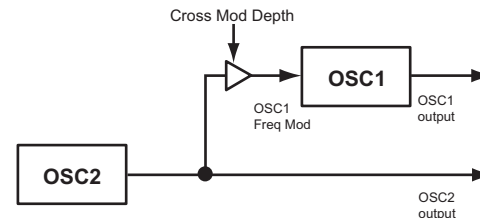

UNISON: Unison simulates skewing the pitch of five stacked oscillators from within a single oscillator, to create a richer sound.

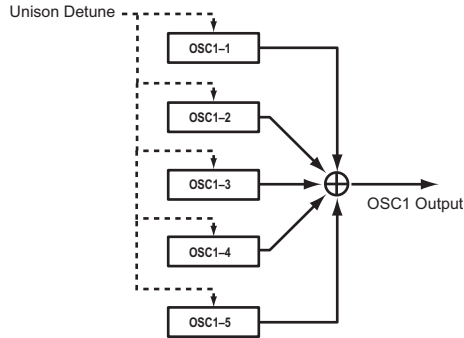

VPM (Variable Phase Modulation):
VPM produces metallic-sounding overtones, using a sine wave at a harmonic (integer) multiple of oscillator 1's fundamental to modulate the phase of oscillator 1.

NOTE If "WAVE" is FORMANT, NOISE, PCM/DWGS, or AUDIO IN, you won't be able to select CROSS, UNISON, or VPM.

OSC1.C1 (Control1) [000...127/-63...+63/---]

OSC1.C2 (Control2) [000...127/-63...+63/001...064/001...032/---]

The function controlled by this knob is determined by the "WAVE" and "OSC MOD" settings. (→ p. 36)



Some settings may produce noise.

NOTE For OSC1.C1 and OSC1.C2, the parameter and settings will depend on the selected "WAVE" and "OSC MOD." You should also refer to the fol-

lowing table when assigning OSC1.C1 or OSC1.C2 to "virtual patch," "KNOB," or GLOBAL "CC MAP."

WAVE	OSC MOD	C1 (OSC1 Control 1)	C2 (OSC1 Control 2)
SAW	WAVEFORM	C1.WAVFRM	C2.LFO1.MD
	CROSS	C1.MOD.DPT	C2.LFO1.MD
	UNISON	C1.DETUNE	C2.PHASE
	VPM	C1.MOD.DPT	C2.HRMNIC
PULSE	WAVEFORM	C1.PLS.WDT	C2.LFO1.MD
	CROSS	C1.MOD.DPT	C2.LFO1.MD
	UNISON	C1.DETUNE	C2.PHASE
	VPM	C1.MOD.DPT	C2.HRMNIC
TRIANGLE	WAVEFORM	C1.WAVFRM	C2.LFO1.MD
	CROSS	C1.MOD.DPT	C2.LFO1.MD
	UNISON	C1.DETUNE	C2.PHASE
	VPM	C1.MOD.DPT	C2.HRMNIC
SINE	WAVEFORM	C1.WAV.SHP	C2.LFO1.MD
	CROSS	C1.MOD.DPT	C2.LFO1.MD
	UNISON	C1.DETUNE	C2.PHASE
	VPM	C1.MOD.DPT	C2.HRMNIC
FORMANT	WAVEFORM	C1.FMT.WDT	C2.FMT.SFT
NOISE	WAVEFORM	C1.RESO	C2.BAL
PCM/DWGS	WAVEFORM		C2.WAV.SEL
AUDIO IN	WAVEFORM	C1.GAIN	

1. When Wave: Saw, Pulse, Triangle, Sine and OSC1 Mod: Waveform

Control1: WAVEFORM..... [000...127]

This modifies the waveform.

• **WAVE: SAW**

The sawtooth wave is appropriate for creating a wide range of sounds typical of analog synthesizers, including basses and pads. Adjusting the value will modify the shape of the waveform, changing the harmonic content. A setting of 000 produces the original sawtooth wave. Higher setting stress different harmonics; a setting of 127 produces a sawtooth wave one octave higher.



• **WAVE: PULSE**

This is a pulse wave suitable for electronic sounds and wind instruments. By adjusting the pulse width you can produce sounds reminiscent of a clavi or sax. A setting of 000 produces a simple square wave. Higher settings narrow the pulse width, and at a setting of 127, the pulse width will disappear completely (no sound).

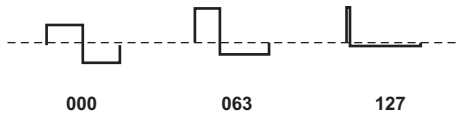

• **WAVE: TRIANGLE**

Triangle waves have fewer overtones than sawtooth or square waves, and they're suitable for mild tone such as bass or pads. Adjusting the value will modify the shape of the waveform, changing the harmonic content. A setting of 000 produces a simple triangle wave. Higher setting stress different harmonics; a setting of 127 produces a triangle wave that is one octave and a fifth higher (i.e., the third harmonic).

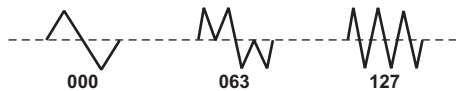

• **WAVE: SINE**

Sine wave is a mild tone that contains only the fundamental frequency with no overtones. A setting of 000 produces a simple sine wave. Increasing this value will modify the waveform, changing the overtone structure as shown below.



Control2: LFO1 Intensity [000...127]

LFO1 will vary the "OSC1.C1" effect (Waveform Modulation.) "OSC1.C2" adjusts the depth of this change. If the LFO1 "WAVE" (→ p. 47 "LFO 1, LFO 2") is set to TRIANGLE, this will produce a detune-like effect for a sawtooth wave ("WAVE": SAW). For a pulse wave ("WAVE": PULSE), it will produce a PWM (Pulse Width Modulation) effect, making the sound thicker.

2. When Wave: Formant and OSC1 Mod: Waveform

Control1: FORMANT WIDTH..... [000...127]

The formant waveform has a tonal character reminiscent of a human voice. This knob will adjust the frequency components that are characteristic of vocal formants. This is similar to the way vowel sounds change depending on the shape of your mouth.

Control2: FORMANT SHIFT [-63...+63]

This moves the entire formant frequency spectrum upward or downward. With a setting of 0, the formant locations are unchanged.

3. When Wave: Noise, and OSC1 Mod: Waveform

Control1: Resonance [000...127]

This parameter adjusts the amount of resonance of the filter provided within the noise oscillator. Higher values will emphasize the frequency points for the pitched component within the noise.

Control2: LPF/HPF Mix [LPF63...CNT...HPF63]

This parameter adjusts the mix balance between the low-pass and high-pass filters; this will vary the brightness of the sound.

4. When Wave: PCM/DWGS and OSC1 Mod: Waveform

Control1: --- (HAS NO EFFECT)

Control2: Wave Select..... [001...64]

Selects the PCM/DWGS waveform.

No.	PCM/DWGS Name	No.	PCM/DWGS Name
1	SG PIANO	33	SYNSINE5
2	ROSE EP (*)	34	SYNSINE6
3	DYNO EP	35	SYNSINE7
4	WURLY EP	36	SYNWAVE1
5	E GRAND	37	SYNWAVE2
6	CLAV1	38	SYNWAVE3
7	CLAV2	39	SYNWAVE4
8	CLAV3	40	SYNWAVE5
9	CXORGAN1	41	SYNWAVE6
10	CXORGAN2	42	SYNWAVE7
11	M1ORGAN1	43	SYNWIRE1
12	M1ORGAN2	44	SYNWIRE2
13	VOX ORG1	45	SYNWIRE3
14	VOX ORG2	46	SYNWIRE4
15	TAPE FLT	47	5THSAW
16	TAPE STR	48	5THSQU
17	BRASS	49	DIGI1
18	GUITAR1	50	DIGI2

No.	PCM/DWGS Name	No.	PCM/DWGS Name
19	GUITAR2	51	DIGI3
20	BASS1	52	DIGI4
21	BASS2	53	DIGI5
22	BASS3	54	DIGI6
23	BELL1	55	DIGI7
24	BELL2	56	DIGI8
25	BELL3	57	DIGI9
26	CHOIR	58	SYNVOX1
27	SYNPAD1	59	SYNVOX2
28	SYNPAD2	60	ENDLESS(**)
29	SYNSINE1	61	NOISE1
30	SYNSINE2	62	NOISE2
31	SYNSINE3	63	NOISE3
32	SYNSINE4	64	NOISE4

*: The waveform number 2: For ROSE EP, the strength of the note velocity will switch the PCM waveform that is sounded.

** : The waveform number 60: Endless simulates the “infinite staircase” sound which produces the same perceived pitch in each different octave. The “infinite staircase” produces the sensation that you never get any higher, no matter how long you continue playing the notes C, D, E, F, G, A, B, C, D, E, ... upward.

5. When Wave: Audio In and OSC1 Mod” Waveform

Control1: Gain [-63...+63]

This parameter adjusts the volume of the audio input.

Control2: --- (HAS NO EFFECT)

6. When Wave: Saw, Pulse, Triangle, Sine and OSC1 Mod: Cross

Control1: Modulation Depth..... [000...127]

This parameter adjusts the cross modulation depth.

Control2: LFO 1 Intensity [000...127]

This parameter adjusts the depth of the additional modulation applied by LFO1 to the cross modulation effect.

7. When Wave: Saw, Pulse, Triangle, Sine and OSC1 Mod: Unison

Control1: Detune [000...127]

This parameter adjusts the difference in pitch between the five unison oscillators. Higher values will broaden the pitch difference between the oscillators, producing a richer sound.

Control2: Phase [000...127]

Specifies the phase of each oscillator at note-on. This will affect the tone of the attack. A setting of 127 will change the pitch and volume.

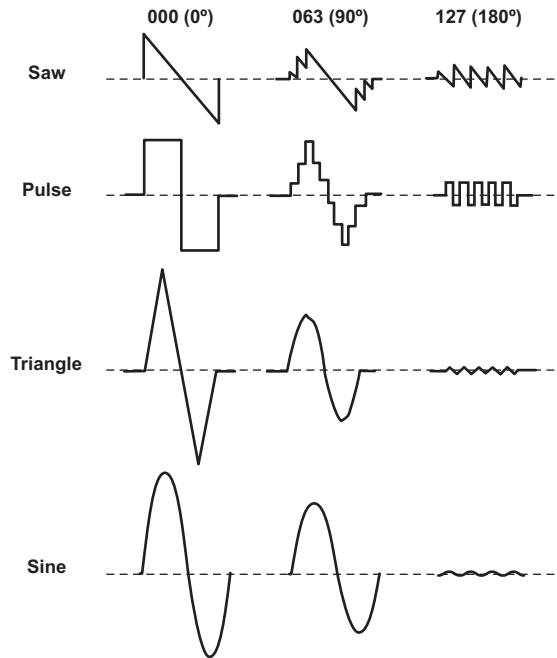

8. When Wave: Saw, Pulse, Triangle, Sine and OSC1 Mod: VPM

Control1: Modulation Depth..... [000...127]

Adjusts the depth of VPM.

Control2: Modulation Harmonics [001...032]

Specifies the frequency of the VPM modulator as a harmonic multiple of oscillator 1.

OSC2 (Oscillator 2)

Here you can make settings for oscillator 2. By using this in conjunction with oscillator 1 you can obtain a variety of sounds. For example by adjusting OSC2 SEMITONE and OSC2 TUNE, you can make one oscillator act as an overtone of the other oscillator. Alternatively, you can create a musical interval by setting each oscillator to a different pitch, or create a detuned effect by setting the two oscillators to slightly different pitches. You can also apply ring modulation or oscillator sync to generate complex overtones (this is done using the OSC2 “OSC MOD” parameter).

WAVE (Waveform Select)..... [SAW, PULSE, TRIANGLE, SINE]

Selects a waveform for oscillator 2.

SAW: A sawtooth wave.

PULSE: A square wave.

TRIANGLE: A triangle wave.

SINE: A sine wave.

NOTE If you do not hear the sound of oscillator 2, go to the MIXER page and raise “OSC2 LVL”. If you want to hear only the sound of oscillator 2, lower the “OSC 1 LVL” on the MIXER page.

OSC MOD (Oscillator 2 Modulation Type) [OFF, RING, SYNC, RNG.SYNC]

This selects the type of oscillator modulation produced by oscillator 2 in conjunction with oscillator 1.

OFF: Oscillator modulation will not be used; the sound of oscillator 2 will be output.

By adjusting the OSC2 “SEMITONE” and “TUNE” settings you’ll be able to create overtone-like components, harmonies, or detune effects.

RING: Oscillator 2 will be used as a ring modulator. By adjusting "SEMITONE" or "TUNE" you can create metallic sounds with little sense of pitch. This is useful for sound effects.

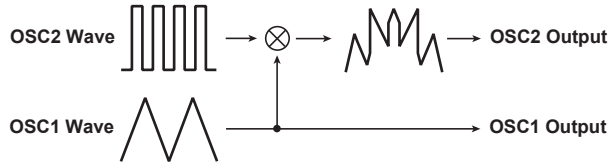

Ring modulation generates the sum and difference of the oscillator 1 and 2 waveforms. For example, select a pulse wave (PULSE for oscillator 1) as the oscillator, set "TRANSPOS" to 0, and "SEMITONE" to 24. Then you can adjust "TUNE" to produce a clear bell-like sound. Using a virtual patch to modulate "OSC2.TUNE" from an LFO or EG can also produce distinctive results.

SYNC: An oscillator sync effect will be produced. This is convenient when creating synth-lead sounds.

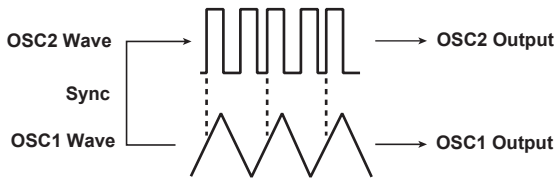

Oscillator sync is a type of modulation in which the phase of oscillator 2 is forcibly synchronized to the phase of oscillator 1. For example, select a sawtooth waveform for the oscillator, and raise the "OSC2 LVL" setting. Then use "SEMITONE" or "TUNE" to change the pitch, and listen to the result. This will be easier to notice if you raise the pitch of oscillator 2 higher than oscillator 1. You can also produce interesting results by using a virtual patch to modulate "OSC2.TUNE" from an LFO or EG.

RING.SYNC: This will apply both RING and SYNC modulation simultaneously.

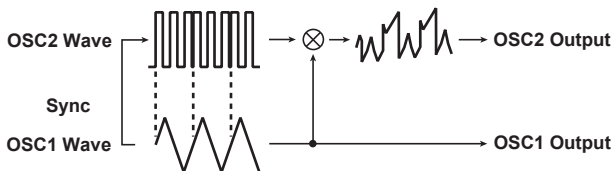

SEMITONE (Oscillator 2 Semitone) [-24...24]

Specifies the detuning (pitch difference) relative to oscillator 1, in semitone steps over a range of plus or minus two octaves.

NOTE If you want to use the sound of oscillator 2 as a component in the oscillator 1 overtone structure, try setting it one octave or a fifth higher than oscillator 1. If you want to use oscillator 2 in harmony, you can try intervals such as a third, fourth, or fifth.

TUNE (Oscillator 2 Tuning) [-63...63]

Specifies the amount of detune for OSC2 relative to OSC1. A setting of ± 63 produces a pitch difference of ± 2 octaves, and ± 48 produces a pitch difference of ± 1 octave. Values near 0 will make fine adjustments in the pitch.

NOTE If the oscillator 2 "OSC MOD" is set to SYNC, adjusting "SEMITONE" or "TUNE" will affect the pitch of the overtones. It will not change the pitch of the fundamental.

MIXER

These parameters adjust the volume balance of the oscillator 1 and 2, and the noise generator. These settings will be the input level to the filter section.

OSC1 LVL (OSC1 Level).....[000...127]

Sets the output level of oscillator 1.

OSC2 LVL (OSC2 Level).....[000...127]

Sets the output level of oscillator 2.

NOISE.LVL (Noise Level) [000...127]

Sets the output level of the noise generator. This noise generator generates white noise. This is independent of the white noise that can be selected as a waveform for oscillator 1 ("WAVE": NOISE.) This does not have filter or resonance as the oscillator 1 noise generator does, but you can use the FILTER section to create the same results as the noise waveform of oscillator 1.

Noise is used to create percussion instrument sounds, or sound effects such as surf.

PUNCH.LVL (Punch Level) [000...127]

Creates a more “snappy” attack by adjusting the amount of pulse waveform that is added to the oscillator output only during the attack. Increasing this value will emphasize the attack.

FILTER1

The filter section changes the tonal character of the oscillators by passing only the desired portion of the sound - either above (Low Pass), below (High-Pass), or centered on (Band Pass) the cutoff frequency. The **microKORG XL+** has two filters (filter 1 and filter 2), and you can change their routing to create more complex filter sounds.

CUTOFF (Filter1 Cutoff) [000...127]

Sets the cutoff frequency.
 Increasing this value will raise the cutoff frequency.
 “CUTOFF” can be varied by time-variant changes produced by EG1, by keyboard playing dynamics (velocity), and by note location (keyboard tracking).

 If the “CUTOFF” value is set too low, the volume may be extremely low, or you may hear no sound at all.

RESO (Filter1 Resonance) [000...127]

Sets the resonance of the filter. This will emphasize the overtones near the cutoff frequency that is specified by “CUTOFF,” adding a distinctive character to the sound. Increasing this value will increase the effect. Since movement of the “CUTOFF” knob will affect the overtones that are boosted by resonance, it is best to adjust “CUTOFF” and “RESO” in conjunction with each other.

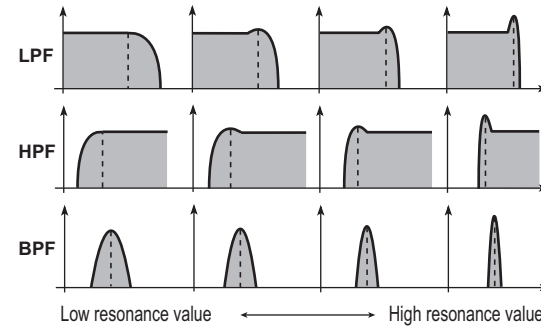

 Depending on the cutoff frequency or the input audio, increasing this value may cause distortion.

TYPE BAL (Filter1 Balance) [LPF24...LPF12...HPF...BPF...THRU]

Selects the filter type. Intermediate settings will produce a response that is between the two filter types.

LPF12 (–12dB/oct), **LPF24** (–24dB/oct): Low Pass Filter.

HPF (–12dB/oct): High Pass Filter.

BPF (–6dB/oct): Band Pass Filter.

THRU: The sound will output directly, without passing through the filter.

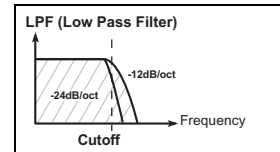
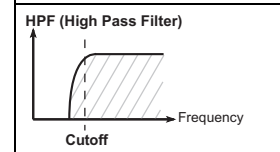
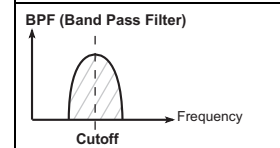
 <p>LPF (Low Pass Filter)</p>	<p>LPF (Low Pass Filter) is the most common type of filter; it passes the frequencies below the cutoff frequency and cuts the region above. Raising the cutoff frequency (“CUTOFF” value) will produce a brighter tone.</p>
 <p>HPF (High Pass Filter)</p>	<p>HPF (High Pass Filter) passes the frequencies above the cutoff frequency and cuts the region below. Use this when you want to make the tone thinner. However, raising the cutoff frequency too far will drastically reduce the volume.</p>
 <p>BPF (Band Pass Filter)</p>	<p>BPF (Band Pass Filter) passes the frequencies in the region of the cutoff frequency, and cuts all other frequency regions. Use this when you want to emphasize only a specific portion of the sound.</p>

ROUTING.....[SINGLE, SERIAL, PARALLEL, INDIV]

Specifies the routing (connection) between filter 1 and filter 2.

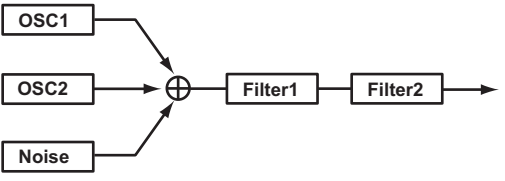
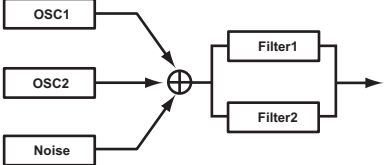
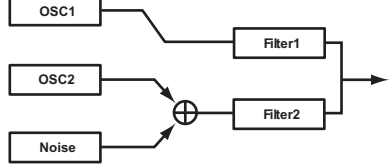
SINGLE	Only filter 1 is used.
SERIAL	Filter 1 and filter 2 are connected in series. 
PARALLEL	Filter 1 and filter 2 are connected in parallel. 
INDIV	Filter 1 is applied to oscillator 1, and filter 2 is applied to oscillator 2 and noise. 

EG1 INT (EG1 Intensity/Filter1) [-63...63]

This specifies how time-variant modulation from the EG1 will be applied to the cutoff frequency.

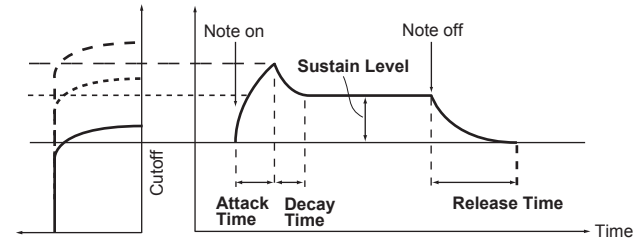

The cutoff frequency will change over time according to the EG1 settings, modifying the tone. For example, you can use this to create a sound that gradually begins to brighten when you press the key, and then gradually becomes darker.

“EG1 INT” parameter specifies the depth (sensitivity) to which the EG1 will affect the cutoff frequency.

With a setting of 0, the EG1 will not affect the cutoff frequency.

Increasingly positive (+) settings will allow the EG1 to have a correspondingly greater effect on the cutoff frequency.

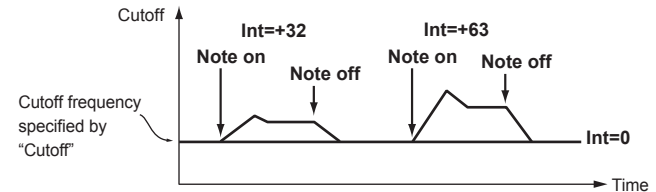

Increasingly negative (–) settings will allow a correspondingly greater effect in the opposite direction.

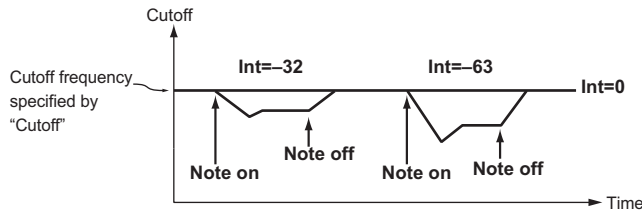

KEY TRK (Keyboard Tracking/Filter1)..... [–2.00...+2.00]

This specifies how keyboard tracking (the keyboard location that you play) will affect the cutoff frequency. For example if the sound played by the C4 key has the desired tone but higher notes no longer have resonance or are too mellow-sounding, you can adjust keyboard tracking to make compensations so that the cutoff frequency will rise for higher notes.

With positive (+) settings, the cutoff frequency will rise as you play upward from the C4 note, and fall as you play downward.

With negative (–) settings, the cutoff frequency will fall as you play upward from the C4 note, and rise as you play downward.

NOTE With a setting of +1.0, the change in cutoff frequency will be proportionate to the change in pitch. With a setting of 0, keyboard tracking will not affect the cutoff frequency.

NOTE Keyboard Track operates according to the pitch that is controlled by pitch bend, and transpose. It is not affected by pitch changes produced by vibrato or Virtual Patch.

VEL SENS (Velocity Sensitivity/Filter1) [–63...+63]

Specifies how velocity (keyboard playing dynamics) will affect the cutoff frequency.

Positive (+) values will cause the cutoff frequency to rise as you play more strongly.

Negative (–) values will cause the cutoff frequency to fall as you play more strongly.

FILTER2

Here you can adjust the settings of the filter 2 parameters. The FILTER1 page “ROUTING” parameter specifies how filter 2 and filter 1 will be connected.



The filter 2 parameters are not shown if “ROUTING” is SINGLE.

CUTOFF (Filter2 Cutoff) [000...127]

This is the same as for FILTER 1 (→ p. 42).

RESO (Filter2 Resonance) [000...127]

This is the same as for FILTER 1 (→ p. 42).

TYPE (Filter2 Type)..... [LPF, HPF, BPF]

Selects the filter type.

LPF, HPF, BPF: These are the same filter type as for filter 1 (→ p. 42).

EG1 INT (EG1 Intensity/Filter2) [–63...63]

This is the same as for FILTER 1 (→ p. 43).

KEY TRK (Keyboard Tracking/Filter2) [–2.00...+2.00]

This is the same as for FILTER 1 (→ p. 44).

VEL SENS (Velocity Sensitivity/Filter2)..... [–63...+63]

This is the same as for FILTER 1 (→ p. 44).

AMP (Amplifier)

These parameters control the volume. The sound that is created by passing through the oscillator and filter is amplified by the amp.

LEVEL..... [000...127]

Adjusts the volume of the timbre.

PANPOT [L63...CNT...R63]

Adjusts the location of the sound in the stereo field. L63 is far left, CNT is center, and R63 is far right.

KEY TRK (Keyboard Tracking) [–63...63]

Specifies how keyboard tracking will affect the volume.

With positive (+) settings, the volume will increase as you play above the C4 note on the keyboard, and will decrease as you play below C4. With negative (-) settings, the volume will decrease as you play above the C4 note on the keyboard, and will increase as you play below C4.

NOTE Keyboard Track operates according to the pitch that is controlled by pitch bend, and transpose. It is not affected by pitch changes produced by vibrato or Virtual Patch.

DRIVE/WS (Drive/Wave Shape)

In this page you can set the Drive or Wave Shape parameters. This lets you add distortion to the sound and give it a distinctive impact.

TYPE (Wave Shape Type)[OFF, DRIVE...LVL BOOST]

This switches wave shaping on/off, and selects the type. Wave shaping modifies the input waveform by applying a transformation of the type you specify here, and produces an output waveform that includes the components of both the input waveform and the transformation shape. "WS DEPTH" specifies the depth of this effect.

 Some settings may produce noise.

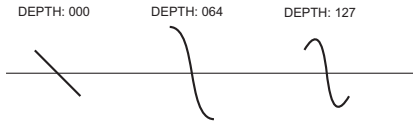
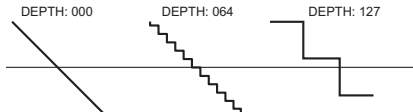
OFF	Wave Shape/Drive is off.
DRIVE	<p>Drive will be applied. The amount of distortion is adjusted by the output level of each oscillator in the MIXER page.(→ p. 41)</p> <p>DEPTH: 000 DEPTH: 064 DEPTH: 127</p>  <p>NOTE Only the Drive setting differs from the wave shape effect.</p>
DECIMATR	<p>Lowers the sampling frequency.</p> <p>DEPTH: 000 DEPTH: 064 DEPTH: 127</p> 

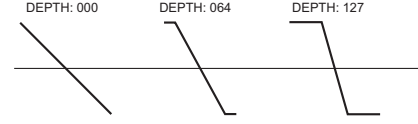
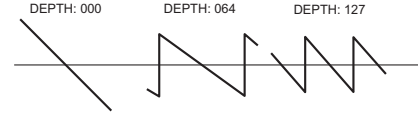
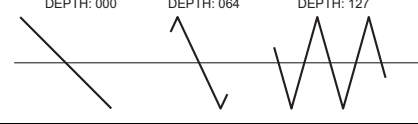
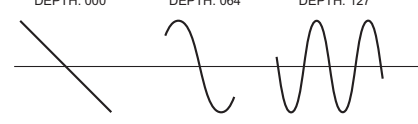
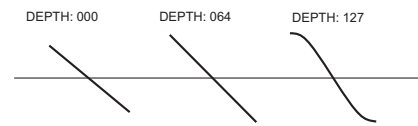
HARD.CLIP	<p>Flattens any portion of the waveform above the limit.</p> <p>DEPTH: 000 DEPTH: 064 DEPTH: 127</p> 
OCT SAW	<p>Cuts the portion of the waveform above the threshold level and inverts it to keep it within limits.</p> <p>DEPTH: 000 DEPTH: 064 DEPTH: 127</p> 
MULTI.TRI	<p>Sending a sawtooth wave through this will produce a triangle wave.</p> <p>DEPTH: 000 DEPTH: 064 DEPTH: 127</p> 
MULTI.SIN	<p>Sending a sawtooth wave through this will produce a sine wave.</p> <p>DEPTH: 000 DEPTH: 064 DEPTH: 127</p> 
SB.OSC.SAW, SB.OSC.SQU, SB.OSC.TRI, SB.OSC.SIN	<p>The selected waveform will sound one octave below oscillator 1. "DEPTH" adjusts the mix amount relative to oscillator 1.</p>
LVLBOOST	<p>Boosts the output level. "WS DEPTH" adjusts the amount of boost.</p> <p>DEPTH: 000 DEPTH: 064 DEPTH: 127</p>  <p>NOTE This may produce high output volumes than other wave shape types.</p>

POSITION [PRE FILT1, PRE AMP]

Specifies the position at which the drive or wave shape functions will be applied.

PRE FILT1: Drive or wave shape will be applied before filter 1.



PRE AMP: Drive or wave shape will be applied after the filter and before the amp.



WS DEPTH (Wave Shape Depth) [000...127]

Specifies the depth at which the drive or wave shape functions will be applied.

EG1

Here you can adjust settings for the filter EG that causes the sound to vary over time. Make EG settings in this page, and then use filter 1 “EG1 INT” (→ p. 43) and filter 2 “EG1 INT” (→ p. 44) to specify the amount of effect that the EG will have. Use the ADSR (Attack, Decay, Sustain, Release) settings to adjust the desired curve for the tone.

NOTE EG1 can be used as a virtual patch source, allowing you to modulate a parameter other than volume (→ p. 49).

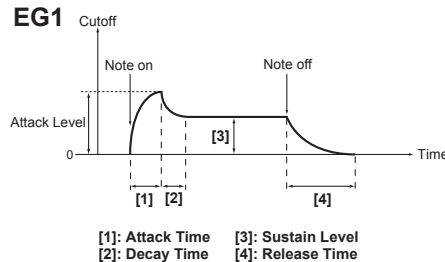

EG (Envelope Generator)

To a significant extent, each sound has its own distinctive volume curve. For example when you play a note on a piano, the note begins at the maximum volume, and gradually diminishes. When you release your finger from the key, the sound will disappear quickly with a brief decay. Volume curves

such as this are an important aspect of how we identify the sound of a specific instrument. This type of change also occurs in the tone and pitch, as well as in the volume. On a synthesizer, this type of change is produced by an EG. The **microKORG XL+** has dedicated EGs for the filter and for the amp. However since these EGs can be used as Virtual Patch sources, you are also free to use them to vary the pitch or numerous other aspects of the sound.

Some example amp EG settings are shown below.

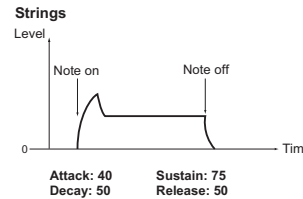
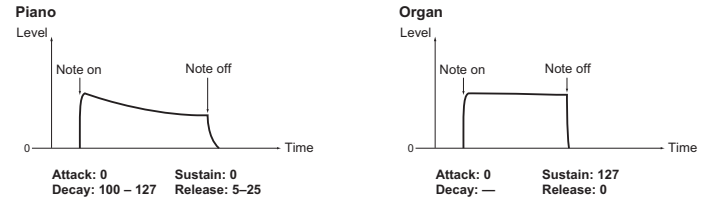

ATTACK (Attack time EG1) [000...127]

Specifies the time from note-on (when the key is pressed) until the attack level (maximum value of the envelope) is reached.

DECAY (Decay time EG1) [000...127]

Specifies the time from when the attack level is reached until the sustain level (SUSTAIN) is reached.

SUSTAIN (Sustain level EG1) [000...127]

Specifies the cutoff frequency that will be maintained after the decay time has elapsed, until you release the key.

RELEASE (Release time EG1) [000...127]

Specifies the time from note-off (when the key is released) until the level reaches 0.

VEL INT (Velocity Intensity) [-63...+63]

This specifies how your keyboard velocity (playing strength) will affect the amplitude of EG1. Higher settings of this parameter will allow changes in your keyboard velocity to produce greater differences in EG amplitude.

EG2

Here you can adjust the settings for the AMP EG, which applies time-variant change to the volume. Using the AMP EG settings, you can make the volume change as time passes. Create the desired volume curve by adjusting the ADSR parameters; ATTACK, DECAY, SUSTAIN, RELEASE.

NOTE You can use EG2 as a Virtual Patch source to modulate parameters other than volume. (→ p. 49)

EG1 and EG2

As the EG1 (Filter EG) changes the cutoff frequency, the tone will change. However, the overall character of the sound will also depend on the volume changes produced by the EG2 (Amplifier EG). For example, setting a long decay for the Filter EG (EG1) will produce a different sound depending on how the decay is set in the Amp EG (EG2). It's a good idea to be aware of both the EG 1(tone) settings and the EG2 (volume) settings as you're editing.

ATTACK (Attack level EG2) [000...127]

Specifies the time from note-on (when the key is pressed) until the attack level (maximum value of the envelope) is reached.

DECAY (Decay level EG2) [000...127]

Specifies the time from when the attack level is reached until the sustain level (SUSTAIN) is reached.

SUSTAIN (Sustain level EG2) [000...127]

Specifies the volume that will be maintained after the decay time has elapsed, as long as you continue holding the key.

RELEASE (Release time EG2) [000...127]

Specifies the time from note-off (when the key is released) until the level reaches 0.

VEL INT (Velocity Intensity) [-63...+63]

This specifies how your keyboard velocity (playing strength) will affect the amplitude of EG2. Higher settings of this parameter will allow changes in your keyboard velocity to produce greater differences in EG amplitude.

EG3

Here you can adjust the settings of EG3. Create the desired curve by adjusting the ADSR parameters; ATTACK, DECAY, SUSTAIN, RELEASE.

NOTE You can use EG3 as a Virtual Patch source to modulate parameters other than filter cutoff (EG1) or volume (EG2). (→ p. 49)

ATTACK (Attack time EG3) [000...127]

Specifies the time from note-on (when the key is pressed) until the attack level (maximum value of the envelope) is reached.

DECAY (Decay time EG3) [000...127]

Specifies the time from when the attack level is reached until the sustain level (SUSTAIN) is reached.

SUSTAIN (Sustain level EG3) [000...127]

Specifies the volume that will be maintained after the decay time has elapsed, as long as you continue holding the key.

RELEASE (Release time EG3) [000...127]

Specifies the time from note-off (when the key is released) until the level reaches 0.

VEL INT (Velocity Intensity) [-63...+63]

This specifies how your keyboard velocity (playing strength) will affect the amplitude of EG3. Higher settings of this parameter will allow changes in your keyboard velocity to produce greater differences in EG amplitude.

LFO 1, LFO 2

Each timbre contains two LFOs. An LFO produces a cyclic change that can be used to modulate the pitch, tone, or volume of the sound.

NOTE LFO1 and LFO2 can be used as Virtual Patch sources to apply modulation to a variety of parameters. (→ p. 49)

LFO (Low Frequency Oscillator)

The LFO (Low Frequency Oscillator) is an oscillator that produces a relatively slow (low-frequency) oscillation, and is used to apply cyclic modulation to various aspects of the sound. Some typical ways to use LFO are vibrato (use LFO to raise and lower the pitch), wah (use LFO to raise and lower the cutoff frequency), and tremolo (use LFO to raise and lower the volume). You can select LFO as a Virtual Patch source, select the desired parameter as the destination, and apply modulation to produce various effects. The **microKORG XL+** provides special parameters that can be modulated from an LFO. If the OSC1 page "OSC MOD" parameter is set to WAVEFORM, the LFO1 will be able to modulate the "C2.LFO1.MD" parameter, and the LFO2 will be able to modulate the PITCH page "VIB INT" parameter.

WAVE (LFO1) [SAW, SQUARE, TRIANGLE, S&H, RANDOM]

WAVE (LFO2) [SAW, SQUARE+, SINE, S&H, RANDOM]

Selects the LFO waveform.

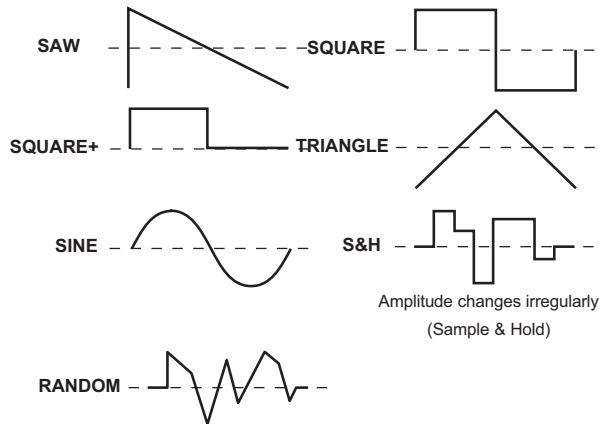

KEY SYNC [OFF, TIMBRE, VOICE]

Specifies how the LFO will be applied to a voice when note-on occurs.

OFF: The LFO phase will not be reset when note-on occurs.

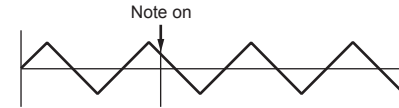

TIMBRE: The phase of the LFO will be reset by the first note-on that occurs from a condition of no keys being held; it will not be reset for subsequently played voices.

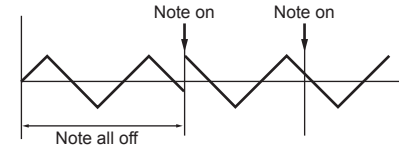

VOICE: The LFO phase will be reset at each note-on, and modulation of differing phases will apply to each voice.

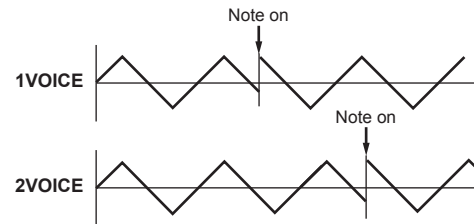

BPM SYNC [OFF, ON]

Specifies whether the LFO cycle will be synchronized to the internal tempo or to an external MIDI Clock.

OFF: The LFO will not be synchronized. It will operate at the frequency specified by the "FREQ" parameter.

ON: The LFO will be synchronized to the [TEMPO] knob or to MIDI Clock messages from an external device.

NOTE If "BPM SYNC" is On, selecting LFO1FREQ or LFO2FREQ as "DEST" in PATCH 1-6 will have no effect.

FREQ (Frequency).....[0.01...100.0Hz]

Specifies the frequency of the LFO. Increasing this value will result in a faster frequency.

NOTE This parameter will be displayed and can be set only if “BPM SYNC” is OFF.

SYNC.NOTE..... [8/1...1/64]

This specifies the ratio of the LFO frequency relative to the tempo specified by the [TEMPO] knob. The specified value (note value) corresponds to one cycle. For example if this is set to 1/4, one cycle of the LFO will occupy one beat. If this is set to 3/4, one cycle of the LFO will occupy three beats.

NOTE This parameter will be displayed and can be set only if “BPM SYNC” is ON.

PATCH 1, PATCH 2, PATCH 3, PATCH 4, PATCH 5, PATCH 6

To let you create even more sophisticated sounds, the **microKORG XL+** provides six virtual patches. Each patch consists of three parameters: the source of the modulation (“SOURCE”), the destination to which that modulation will apply (“DEST”), and the intensity of that modulation effect (“INTENSITY”). You can produce a variety of changes in the sound by combining these parameters. For example by setting “SOURCE” to LFO2, “DEST” to CUTOFF1, and specifying the amount of effect using “INTENSITY,” you can produce a cyclic change in tone (wah effect) produced by LFO2.

Virtual Patch

On modular analog synthesizers, the input or output of each module (oscillator, filter, amp, EG, LFO, and other controllers) could be connected (“patched”) by a patch cord to any other module as desired, allowing you a great deal of freedom in creating the sound. The Korg MS Series (MS-20, MS-50, MS-10, etc.) went on sale in 1978 and featured this type of patching. The **microKORG XL+** lets you perform this patching “virtually” (i.e., without using physical patch cords), so you can assign sources such as EG or LFO to the most important parameters (destinations).

SOURCE..... [EG1...MIDI3]

Selects a modulation source.

EG1, EG2, EG3	EG1, EG2, or EG3.
LFO1, LFO2	LFO1 or LFO2.
VELOCITY	Keyboard velocity (playing dynamics).
P.BEND	Pitch bend.
MOD.WHEEL	Modulation wheel.
KEY TRK	Keyboard tracking (position). NOTE Keyboard tracking works according to the pitch as controlled by pitch bend, transpose, and modulation sequencer. It does not reflect pitch changes produced by vibrato or virtual patching.
MIDI1, MIDI2, MIDI3	The function specified for the MIDI.CTRL page parameters “MIDI1,” “MIDI2,” or “MIDI3.”

DEST (Destination).....[PITCH...P.INT6]

Selects the parameter (destination) that will be controlled by the modulation. For example if you select Tune, modulation will be applied to the overall pitch of the timbre.

PITCH	The pitch of the entire timbre.
OSC2.TUNE	The OSC2 page “TUNE”.
OSC1 C1	The OSC1 page “C1”. (→ p. 36)
OSC1 LVL	The MIXER page “OSC1 LVL”.
OSC2 LVL	The MIXER page “OSC2 LVL”.
NOISE.LVL	The MIXER page “NOISE.LVL”.
FILT1.BAL	The FILTER1 page “TYPE BAL”.
CUTOFF1	The FILTER1 page “CUTOFF”.
RESO1	The FILTER1 page “RESO”.
CUTOFF2	The FILTER2 page “CUTOFF”.
WS DEPTH	The DRIVE/WS page “DEPTH”.
LEVEL	The AMP page “LEVEL”.
PANPOT	The AMP page “PANPOT”.
LFO1.FREQ	The LFO1 page “FREQ”.
LFO2.FREQ	The LFO2 page “FREQ”.
PORTMNT0	The PITCH page “PORTMNT0”.
OSC1 C2	The OSC1 page “C2”. (→ p. 36)
EG1 INT1	The FILTER1 page “EG1 INT”.
KEY TRK1	The FILTER1 page “KEY TRK”.
RESO2	The FILTER2 page “RESO”.

EG1 INT2	The FILTER2 page "EG1 INT".
KEY TRK2	The FILTER2 page "KEY TRK".
ATTACK1	The EG1 page "ATTACK".
DECAY1	The EG1 page "DECAY".
SUSTAIN1	The EG1 page "SUSTAIN".
RELEASE1	The EG1 page "RELEASE".
ATTACK2	The EG2 page "ATTACK".
DECAY2	The EG2 page "DECAY".
SUSTAIN2	The EG2 page "SUSTAIN".
RELEASE2	The EG2 page "RELEASE".
ATTACK3	The EG3 page "ATTACK".
DECAY3	The EG3 page "DECAY".
SUSTAIN3	The EG3 page "SUSTAIN".
RELEASE3	The EG3 page "RELEASE".
P.INT1	The PATCH1 page "INTENSTY".
P.INT2	The PATCH2 page "INTENSTY".
P.INT3	The PATCH3 page "INTENSTY".
P.INT4	The PATCH4 page "INTENSTY".
P.INT5	The PATCH5 page "INTENSTY".
P.INT6	The PATCH6 page "INTENSTY".

INTENSTY (Patch Intensity)[-63...63]

Specifies the depth of the effect produced by the modulation source.
With a setting of 0, there will be no modulation.

Setting example for "SOURCE" and "DEST"

SOURCE [1]	▶ DEST [2]	
EG1/EG2	▶ PITCH	The EG1 or EG2 will vary the pitch of the entire timbre over time.
EG1/EG2	▶ PANPOT	The EG1 or EG2 will vary the pan over time. By setting two patches to "MOD INT" settings with the opposite (+/-) value you can create more complex panning.
LFO 1/LFO 2	▶ PITCH	Vibrato will be applied at the LFO1 or LFO2 frequency.
LFO 1/LFO 2	▶ CUTOFF	Wah will be applied at the LFO1 or LFO2 frequency.
LFO 1/LFO 2	▶ LEVEL	Tremolo will be applied at the LFO1 or LFO2 frequency.
LFO 1/LFO 2	▶ PANPOT	Auto pan will be applied at the LFO1 or LFO2 frequency.
VELOCITY	▶ LEVEL	Velocity (keyboard playing strength) will affect the volume.
KEY TRK	▶ PANPOT	Keyboard position will gradually change the pan; lower notes at the left, and higher notes at the right.
P.BEND	▶ PANPOT	PITCH wheel operations or pitch bend change will move the sound between left and right.

EQ (Equalizer)

Here you can adjust the equalizer settings. The equalizer is a shelving type.

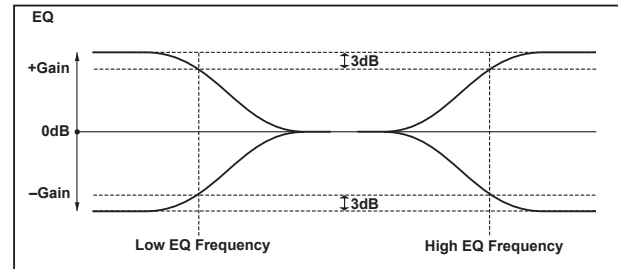

LO FREQ (Low EQ Frequency) [0020...1000Hz]

Specifies the frequency of the low equalizer.

LO GAIN (Low EQ Gain) [-15.0...+15.0dB]

Specifies the gain of the low equalizer.
Positive (+) values boost the region below the cutoff frequency.

Negative (–) values cut the region below the cutoff frequency.

HI FREQ (High EQ Frequency) [1.00...20.0kHz]

Specifies the cutoff frequency of the high equalizer.

HI GAIN (High EQ Gain) [–15.0...+15.0dB]

Specifies the gain of the high equalizer.

Positive (+) values boost the region above the cutoff frequency.

Negative (–) values cut the region above the cutoff frequency.

MST FX1, MST FX2 (Master effect 1, 2)

In On this page you can adjust settings for the master effects. You can choose from seventeen types.

[FX.TYPE] [“FX OFF” ... GRAIN.SFT]

This selects the effect type used by the master effect. For details on the available effects, refer to page 63 “Effect guide”.

[CTRL-1] [MST FX PARAM...]

[CTRL-2] [MST FX PARAM...]

These specify the parameters that will be controlled by knobs [1]–[3] when you set the [KNOB FUNCTION SELECT] dial to ASSIGN or EFFECT. For details on knob assignments for effect parameters, refer to page 63 “Effect knob assignments”.

2. Arpeggio parameters

Front Panel Arpeggio Parameters

[TEMPO] knob

Specifies the playback tempo of the arpeggiator.

NOTE The speed of modulation sequences and LFOs for which “BPM Sync” is On will be synchronized to the tempo you specify here.

ARPEGGIATOR TEMPO LED

This will blink at quarter-note intervals of the tempo specified by the [TEMPO] knob.

ARPEGGIATOR [ARP ON] button

Switches the arpeggiator on/off. The button will light if this is on.

ARP (ARPEGGIATOR)

Here you can make various arpeggio-related settings.

ASSIGN [TIMBRE1, TIMBRE2, TMBR1+2]

Selects the timbre(s) that will be sounded by the arpeggiator.

TYPE (Arpeggio type) [UP, DOWN, ALT1, ALT2, RANDOM, TRIGGER]

Selects the arpeggio type.

UP: Notes will be played consecutively from low pitches to high.

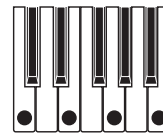

DOWN: Notes will be played consecutively from high pitches to low.



ALT1: Up and Down will be alternated. (The highest and lowest notes will be played once.)



ALT2: Up and Down will be alternated. (The highest and lowest notes will be played twice, once on the way up, and once on the way down.)



RANDOM: Notes will be played randomly.



TRIGGER: The notes you are holding down will be played simultaneously at the tempo and "RESOLUTN" timing. The "OCT.RANGE" setting will be ignored.



NOTE If you are holding down more notes than the maximum polyphony of the timbre, the lowest pitches you are holding down will be played, up to the maximum polyphony.

LATCH[OFF, ON]

This specifies how the arpeggiator will behave when you take your hand off the keyboard.

OFF: The arpeggiator will stop when you take your hand off the keyboard.

ON: The arpeggiator will continue playing even if you take your hand off the keyboard.

OCT.RANGE (Octave Range) [1, 2, 3, 4]

Specifies the range of octaves over which the arpeggio will be played.

LAST.STEP [1...8]

Specifies the number of valid steps (maximum number of steps) for the arpeggiator.

GATE.TIME [000%...100%]

Specifies the duration (gate time) of the arpeggiated notes, as a percentage (%). With a setting of 001%, each note will be extremely short. With set to 100%, each note will continue playing until the next step.

SWING (Arpeggiator Swing) [-100%...+100%]

Specifies the percentage (%) by which even-numbered notes of the arpeggio will be shifted in timing relative to the first note.

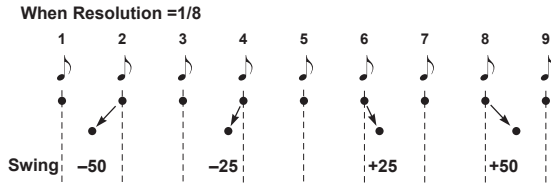

RESOLUTION (Resolution) [1/32...1/1]

Specifies the resolution (spacing of the notes) relative to the tempo specified by [TEMPO] knob.

- 1/32: The arpeggio will be played as 32nd notes at the specified tempo.
- 1/24: The arpeggio will be played as 16th note triplets at the specified tempo.
- 1/16: The arpeggio will be played as 16th notes at the specified tempo.
- 1/12: The arpeggio will be played as 8th note triplets at the specified tempo.
- 1/8: The arpeggio will be played as 8th notes at the specified tempo.
- 1/6: The arpeggio will be played as quarter note triplets at the specified tempo.
- 1/4: The arpeggio will be played as quarter notes at the specified tempo.
- 1/2: The arpeggio will be played as half notes at the specified tempo.
- 1/1: The arpeggio will be played as whole notes at the specified tempo.

KEY SYNC [OFF, ON]

Specifies whether the arpeggiator will be synchronized to the keyboard. If this is On, the arpeggiator will always start from the beginning of the arpeggio pattern when you play the keyboard. If you are performing together with other instruments, you can use this function to ensure that the arpeggio pattern is aligned with the beginning of the measure.

OFF: Sync off. The arpeggio pattern will not be reset when you play the keyboard.

ON: Sync on. The arpeggio pattern will be reset the moment you play the keyboard.

ARP.STEP (Arpeggiator Step)

Here you can turn each step of the arpeggio pattern on/off. This is a way to give more variety to arpeggios that might become boring.

TRIGGER [OFF, ON]

Specify the on/off status of each step 1-8.

The number of available steps is specified by the "LAST.STEP" setting.

- (OFF): The note at this step will not sound.

O (ON): The note at this step will sound.

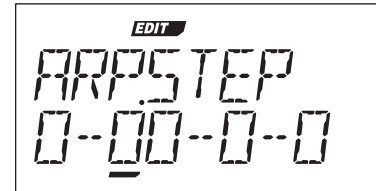

Note status:

- O: Will sound
- : Won't sound

3. Edit utility parameters

UTILITY

Here are program-related utility functions.

INIT.PROG (INITIALIZE PROGRAM).....

This initializes the settings of the selected program. (→ p. 28)

COPY.TMBR (COPY TIMBRE)

This copies timbre settings from another program to a timbre of the currently selected program. (→ p. 28)

4. Vocoder parameters

Front panel vocoder parameters

[VOCODER] button

This switches the Vocoder function on/off.

Off (LED unlit): Vocoder is off. The program will not use the vocoder.

On (LED lit): The vocoder is on. The program will be a vocoder program, and the vocoder parameters will be available for editing.

If you turn the [KNOB FUNCTION SELECT] dial to FULL EDIT, you'll be able to edit the vocoder parameters (VC CARRI–VC BAND pages).

VC CARRI (Vocoder Carrier)

On this page you can set the input level of the audio signal being used as the carrier

TMBR1.LVL (Timbre1 Level)[000...127]

Specifies the output level of Timbre1 (carrier).

INPUT2.LVL (Timbre2 Level)[000...127]

Specifies the output level of Timbre2.

VC MOD (Vocoder Modulator)

In this page you can adjust settings for the modulator, which applies its character to the carrier audio.

For the modulator, you can use an external audio source such as a mic or rhythm (AUDIO IN) or timbre 2.

SOURCE (Audio Source)..... [INPUT, TIMBRE2]

This selects the audio source that will be sent to the modulator.

INPUT: The audio source of AUDIO IN will be sent to the modulator.

When the AUDIO IN [XLR/LINE] is set to LINE, the source from the rear panel AUDIO IN [LINE] jack will be sent to the modulator.

When the AUDIO IN [XLR/LINE] is set to XLR, the sound from the mic connected to the front panel AUDIO IN [MIC] (XLR type) jack will be sent to the modulator. This is the typical “vocoder using a mic” setup.

TIMBRE2: The output of timbre 2 will be input to the modulator.

GATE.SENS (Gate Sensitivity) [000...127]

Specifies the speed at which the gate will operate according to the "THRESHLD" setting.

Lower values for this setting will make the gate close more quickly, causing the vocoder sound to decay more quickly.

Higher values for this setting will make the gate close more gradually, causing the vocoder sound to have a longer decay.

NOTE If the "THRESHLD" value is high, this effect will apply more readily. If the threshold value is 0, there will be no effect.

THRESHLD (Threshold) [000...127]

Sets the level at which the input source will be cut. By setting this to an appropriate level, you can cut the noise that might be present during times where there is no input. Higher settings will make it more likely that the input source will be cut.



With excessively high settings, it's more likely that the audio input signal itself will be cut, making it difficult for you to apply the vocoder effect as intended.

HPF GATE [DISABLE, ENABLE]

The **microKORG XL+**'s vocoder can extract the high-frequency portion from the audio source being input to the modulator, and then mix this into the output of the vocoder. You can specify whether this high-frequency portion will be mixed in only while the internal sound generator (Timbre1) is producing sound, or at all times.

DISABLE: The high-frequency portion will be mixed whenever the audio source is being input to the modulator.

ENABLE: The high-frequency portion of the audio source will be mixed only when the internal sound generator (Timbre1) is producing sound.

HPF LVL (HPF Level) [000...127]

This adjusts the output level from the HPF (High Pass Filter) that extracts the high-frequency components from the modulator input source; these high-frequency components are then mixed into the output of the vocoder. Increase this value if you want to emphasize the consonants of the vocal input source.

VC FILT (Vocoder Filter)

Here you can adjust the settings for the carrier's sixteen band-pass filters and modulator's envelope filter. You'll be using these parameters frequently, since they play an important role in determining the character of the vocoder.

FRMNT.SFT (Formant Shift) [-2...+2]

Shifts the cutoff frequencies of each of the carrier's band pass filters. This will significantly change the character of the vocoder output.

FC.OFFSET (Fc Offset)..... [-63...+63]

This continuously shifts the cutoff frequency of each band-pass filter (Synthesis filter) of the carrier.

"FRMNT.SFT" and "FC.OFFSET"

When "FRMNT.SFT"=0 and "FC.OFFSET"=0, the response of the carrier filters will match the cutoff frequency of the modulator filters. The filter response is shifted upward or downward in two discrete steps by the "FRMNT.SFT." This can be adjusted upward or downward a total of another two steps by using "FC.OFFSET," giving you a total of four steps of adjustment upward or downward.

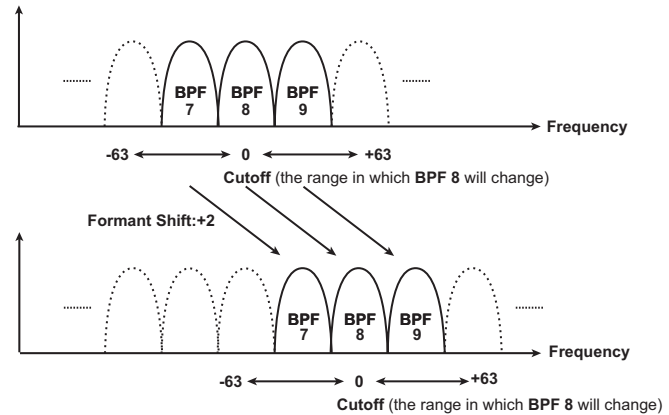

RESO (Vocoder Resonance)..... [000...127]

This specifies the amount of resonance for each of the carrier's sixteen band-pass filters (the synthesis filter). Higher settings will boost the sound in the region of the cutoff frequency.

FC.MOD.SRC (Fc Mode Source)..... [EG1...MIDI3]

Selects the modulation source that will be applied to the carrier band-pass filter "FC.OFFSET."

NOTE The sources you can select are the same as the modulation sources for a virtual patch (→ p. 49 "SOURCE"). However, EG1–3, LFO1–2, VELOCITY, and KEY TRK will be the sources for timbre 1.

FC.MOD.INT (Fc Modulation Intensity)..... [-63...+63]

Specifies the depth of the modulation that is applied to the carrier band-pass filter (Synthesis filter) "FC.OFFSET."

EF.SENS (Envelope Follower Sens) [000...126, HOLD]

Specifies the sensitivity of the modulator's Envelope Followers. Lower settings of this value will allow the attacks of the input signal to be detected more rapidly.

If you set this to Hold, the character of the signal that is being input at that moment will be held (Formant Freeze). Subsequently, the sound will retain that character regardless of whether there is any input.



If you set this to Hold when there is no input signal present, there will be no output even if an audio signal is subsequently input.

NOTE If you write the program with this value set to Hold, the program will memorize the response of the signal that was being held.

VC AMP (Vocoder Amp)

Here are the parameters for modulation and vocoder output.

VC LEVEL (Vocoder Level) [000...127]

Sets the output level of the vocoder.

DIRCT.LVL (Direct Level) [000...127]

Sets the volume level at which the modulator input source will be output directly (unaffected).

VC BAND (Vocoder Band)

These parameters specify the output level and panning (stereo position) for each of the carrier's sixteen band-pass filters (the synthesis filter).

LEVEL1...16 [000...127]

Specifies the output level of each band.

PAN1...16 [L63...R63]

Specifies the panning of each band.

5. Global parameters

The settings you make from the global screen will apply to the entire **microKORG XL+**, such as the overall tuning and the velocity curve.

MST TUNE (Master Tune)[430.0...450.0Hz]

Adjusts the overall pitch in 0.1 Hz steps, in terms of A4 as the reference pitch. Use this when you need to tune the pitch of the **microKORG XL+** to other instruments.

TRANSPOS (Transpose)..... [-12...+12]

Adjusts the overall pitch in steps of a semitone (100 cents) over a range of one octave up or down. Use this when you want to transpose to suit the song you are playing.

VEL.CURVE (Velocity Curve) [1...8, CONST127]

Different velocity curve lets you tailor the response of the keyboard to your own playing style. Lighter curves are best for heavy-handed players, higher curves may work better for players with a light touch.

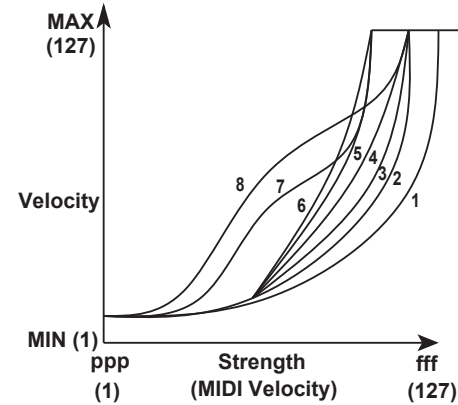

1	This curve requires you to play strongly in order to produce an effect.
2, 3	
4	This is the typical curve.
5	
6	This curve produces an effect without requiring you to play very strongly.
7	This curve produces a fairly steady effect with little change for medium-strength playing.
8	This curve produces a fairly steady effect with little change for medium-strength playing (a flatter curve than 7).
CONST127	All notes will sound maximum velocity (127). This setting mimics the behavior of early analog synths.

NOTE Curves 7 and 8 produce little change for medium-strength playing. However, these curves will produce a great deal of change with softly played notes, so they may be more difficult to control. Choose the curve that is most appropriate for your playing dynamics or for the effect you want to obtain.

POSITION [POST KBD, PRE TG]

Specifies the internal MIDI IN/OUT routing within the **microKORG XL+**. This setting will affect the way in which MIDI data is transmitted and received, and how the arpeggiator data is handled.

POST KBD: In this position, incoming MIDI data will be sent to the timbres without being affected by the global or front panel transpose controls, and will not trigger the arpeggiator. Data produced by the keyboard will be converted according to the internal settings, routed through the arpeggiator (arpeggiator notes are sent as MIDI data), and then sent to the MIDI OUT connector.

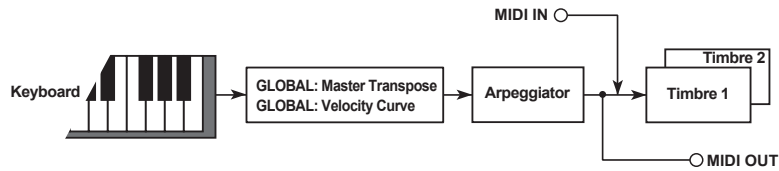

PRE TG: Incoming MIDI data will be affected by the global settings, and will act as trigger notes for the arpeggiator. Data produced by the keyboard will be sent to the MIDI OUT connector without being affected by any setting other than OCTAVE [UP] [DOWN] button.

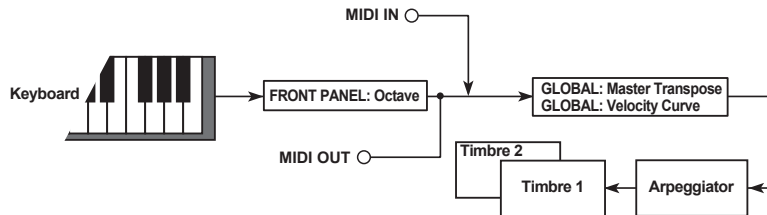

KNOB.MODE [JUMP, CATCH]

Specifies the behavior of the front panel knobs when editing. (→ p. 24)

JUMP: When you turn the knob, the parameter value will jump to the value indicated by the knob, regardless of the stored value. Since this makes it easy to hear the results while editing, we recommend that you use this setting when editing.

CATCH: When you turn the knob, the parameter value will not change until the knob position matches the stored value. We recommend that you use this setting when you don't want the sound to change abruptly, such as during a live performance.

PROTECT [OFF, ON]

This specifies whether internal memory will be protected.

OFF: You'll be able to write to internal memory.

ON: The following Write operations will be prohibited.

- Writing a program
- Loading the factory-set data
- Receiving a data dump

LCD.LIGHT (LCD Backlight mode) [OFF, AUTO, ON]

This switches the mode of the display backlight.

OFF: The backlight will not light.

AUTO: The backlight will light when you turn a knob or operate a switch.

After a time, the backlight will go dark.

ON: The backlight will remain lit.

A. PWR.OFF (Auto Power Off) [DISABLE, 4 HOURS]

This function specifies whether the auto power off function is enabled or disabled.

DISABLE: The auto power off function is disabled. The microKORG XL+ will not be automatically turned off.

4 HOURS: The microKORG XL+ will be automatically turned off if no user input is received for approx. 4 hours.

6. MIDI parameters

MIDI

Here you can adjust MIDI-related settings for the **microKORG XL+**.

MIDI CH (MIDI Channel).....[01...16]

Specifies the MIDI channel. When you wish to transmit program changes or system exclusive messages via MIDI, set the global MIDI channel to match the MIDI channel of the connected MIDI device.

LOCAL.....[OFF, ON]

Switches the local setting on and off.

OFF: With this setting, controllers such as the keyboard and modulation wheel will be internally disconnected from the tone generator section. This setting prevents notes from being sounded in duplicate when the **microKORG XL+** is connected to a sequencer and the performance data is echoed back from the sequencer. (Echo back is when the performance data transmitted by playing the **microKORG XL+** is re-transmitted back to the **microKORG XL+** from the sequencer.)

ON: Select this setting when you are using the **microKORG XL+** by itself.

ROUTING.....[MIDI+USB, USB, MIDI]

Selects the connector(s) that will be used to transmit and receive MIDI messages.

MIDI+USB: The MIDI connectors and USB connector will be used to transmit and receive MIDI messages. When receiving MIDI messages, the messages from both types of connector will be mixed, and MIDI messages received later will be given priority. For transmission, the same MIDI messages will be transmitted from both connectors.

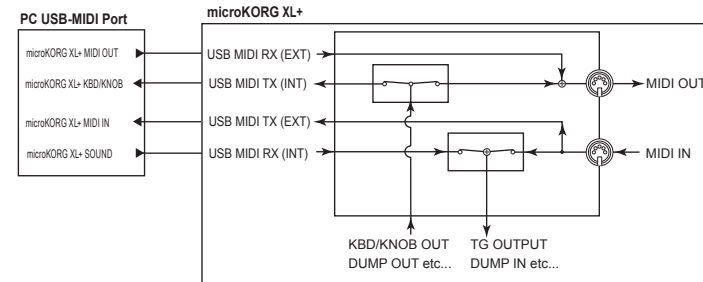

USB: Only the USB connector will be used to transmit and receive MIDI messages.

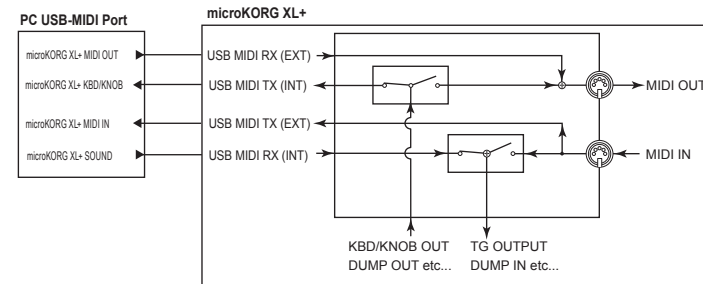

MIDI: Only the MIDI connectors will be used to transmit and receive MIDI messages.

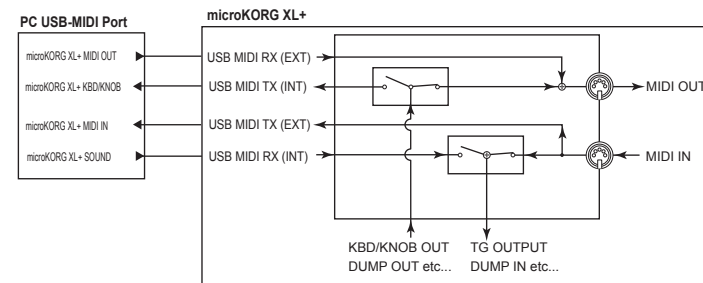

CLOCK [AUTO, INTERNAL, EXT USB, EXT MIDI]

Specifies how the **microKORG XL+** will synchronize with an external MIDI device (sequencer, rhythm machine, etc.). If the LFO 1/2 or delay effect "BPM SYNC" is On, the LFO rate and delay time will also synchronize in the same way as the arpeggiator.

AUTO: The **microKORG XL+** will automatically function using the External (or USB) setting if MIDI clock messages are being received from an external MIDI device connected to the MIDI IN connector. If no MIDI clock messages are being received, the internal setting will be used.

INTERNAL: The arpeggiator will sync to the internal clock (specified by knob [TEMPO]). Select this setting if you are using the **microKORG XL+** by itself, or if you are using the **microKORG XL+** as the master (controlling device) so that an external MIDI device will synchronize to the MIDI clock messages from the **microKORG XL+**.

EXT USB: The **microKORG XL+**'s arpeggiator will synchronize to the MIDI clock messages received from an external USB MIDI device connected to the USB connector.

EXT MIDI: The **microKORG XL+**'s arpeggiator will synchronize to the MIDI clock messages received from an external MIDI device connected to the MIDI IN connector.

NOTE When syncing to an external MIDI device, refer to that device's owner's manual.

MIDI FLT (MIDI Filter)

Here you can adjust the the **microKORG XL+**'s MIDI Filter settings.

PROG CHG (Program Change) [DISABLE, ENABLE]

Selects whether program changes will be transmitted and received.

DISABLE: Program changes will not be transmitted or received.

ENABLE: Program changes will be transmitted and received.

CTRL CHG (Control Change)..... [DISABLE, ENABLE]

Selects whether MIDI control changes will be transmitted and received.

DISABLE: MIDI control changes will not be transmitted or received.

ENABLE: MIDI control changes will be transmitted and received.

P.BEND (Pitch Bend) [DISABLE, ENABLE]

Selects whether pitch bend messages will be transmitted and received.

DISABLE: Pitch bend messages will not be transmitted or received.

ENABLE: Pitch bend messages will be transmitted and received.

SYS EX (System Exclusive) [DISABLE, ENABLE]

Selects whether MIDI system exclusive messages will be transmitted and received.

DISABLE: MIDI system exclusive messages will not be transmitted or received.

ENABLE: MIDI system exclusive messages will be transmitted and received.

MIDI.CTRL (MIDI Control)

In this page you can specify the function that is assigned for modulation sources MIDI1, MIDI2, and MIDI3 used in a virtual patch.

NOTE If the selected function is assigned to a different parameter, an asterisk "*" is shown at the right of the value.

MIDI1.SRC

.... [P.BEND...#119, #016+/-, #017+/-, #019+/-, #020+/-, #021+/-]

Selects the function that will be assigned to modulation source MIDI1 used in a virtual patch. The factory-set default setting is CC#16.

MIDI2.SRC

.... [P.BEND...#119, #016+/-, #017+/-, #019+/-, #020+/-, #021+/-]

Selects the function that will be assigned to modulation source MIDI2 used in a virtual patch. The factory-set default setting is CC#02.

MIDI3.SRC

.... [P.BEND...#119, #016+/-, #017+/-, #019+/-, #020+/-, #021+/-]

Selects the function that will be assigned to modulation source MIDI3 used in a virtual patch. The factory-set default setting is A.TOUCH (aftertouch).

If you've selected #016+/- (CC#16+/-), #017+/- (CC#17+/-), #019+/- (CC#19+/-), #020+/- (CC#20+/-), or #021+/- (CC#0216+/-)

When a control change message is received from a slider (value 0—127) on an external MIDI device, the center position of the slider (control change value 64) will produce a modulation effect of 0 on the **microKORG XL+**.

If you've selected #016, #017, #019, #020, or #021, setting the slider etc. to a position of 0 (control change value 0) will produce a modulation effect of 0 on the **microKORG XL+**. Choose the type of setting that will produce the desired result on the **microKORG XL+** when you operate the sliders or other controllers of your external MIDI device.

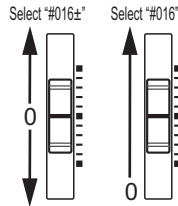

KEY [C...B]

Select the note whose pitch you want to adjust.

(Value) [-63...+63]

-63: The note will be 63 cents flatter than standard pitch.

+63: The note will be 63 cents sharper than standard pitch.

CC MAP (MIDI Control Change No. Map)

Here you can assign control change numbers to the most important parameters. When you use performance editing or program editing, using the knob for these parameters will transmit the control change message that is assigned here. When the assigned control change message is received, the value of the corresponding parameter will change (→ p. 83 "2.MIDI messages").

(Parameter)..... [PORTMNT0...VC.EF.SENS]

Selects the knob parameter (→ p. 33 "KNOB").

(Value) [NO.ASSIGN...CC#119]

Specifies a MIDI control change number (CC#) for the parameter selected by "Parameter."

NOTE If another parameter is assigned to the number you select, an asterisk "*" will appear at the right of the number.

NOTE The MIDI channel for vocoder parameters will be the same MIDI channel as for timbre 1.

USR.SCALE (User Scale)

Here you can specify a user-defined scale. You can specify a pitch adjustment of -63 to +63 cents for each note in the octave (C-B).

7. Global utility parameters

UTILITY

Here are utility functions for the **microKORG XL+**'s data.

MIDI.DUMP (MIDI DATA DUMP) [1 PROG, ALL PROG, GLOBAL, ALL DATA]

You can transmit programs or global data as MIDI exclusive data so that it can be saved on a connected MIDI data filer or computer. You can also transmit data to another **microKORG XL+** unit.

1 PROG: Only the selected program data will be transmitted (the parameters of the NAME–VC BAND pages, and the settings of the front panel keys and knobs).

ALL PROG: All program data will be transmitted.

GLOBAL: Global data will be transmitted (the parameters of the GLOBAL–USR.SCALE page).

ALL DATA: All program data and global data will be transmitted.



Do not touch the **microKORG XL+**'s knobs or keyboard while data is being transmitted. Never turn off the power during this time.



Some MIDI interface devices may be unable to transmit or receive the **microKORG XL+**'s MIDI exclusive data.

PRELOAD..... [1 PROG, ALL PROG, GLOBAL, ALL DATA]

This function restores the **microKORG XL+**'s program or global settings to their original factory-set state.

1 PROG: Only the selected program data will be loaded (the parameters of the NAME–VC BAND pages, and the settings of the front panel keys and knobs).

ALL: All program data will be loaded.

GLOBAL: Global data will be loaded (the parameters of the GLOBAL–USR.SCALE page).

ALL DATA: All program data and global data will be loaded.

Effect guide

1. About the effects

As effects, the **microKORG XL+** provides a two-band EQ and two master effects. You can use the EQ to modify the sound of each timbre, and use the master effects to apply spatial-type processing to the overall sound. For each master effect you can choose one of seventeen full-digital effects, which are categorized as follows.

01–05	Filter and dynamics effects such as EQ and compressor
06–10	Delay-type effects
11–17	Pitch and phase modulation effects such as chorus and phaser

About the effect input and output

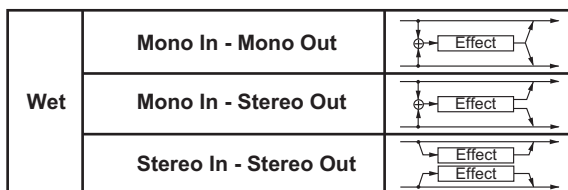

The master effects are stereo-in and stereo-out. In the “DRY/WET” balance, the stereo-input DRY signal (the sound not processed by the effect) is passed through to stereo-output. The way in which the WET signal (the sound processed by the effect) is output will depend on the type of effect, with the following variations.



The input/output variation for each effect is shown in the upper left of the block diagram.

To obtain the best sound quality, you should adjust the input level to the master effect as high as possible without causing clipping. This is done using the AMP “LEVEL” parameter, the MIXER “OSC1 LVL,” “OSC2 LVL,” and “NOISE.LVL” parameters, and the “TRIM” parameter of each effect.

Then use each effect’s “DRY/WET” or “OUT.LEVEL” parameters to adjust the output level of the effect.

-  Some effect types do not have a “TRIM” or “OUT.LEVEL” parameter.
-  There is no input level meter etc. to check the input level to the effect. Insufficient input level will produce a poor S/N ratio, while excessive input level will cause clipping.

Controlling effect parameters

You can use the front panel knobs [1], [2], and [3] to control effect parameters in realtime. The parameters assigned to knobs can also be controlled from an external MIDI device.

Effect knob assignments

When the [KNOB FUNCTION SELECT] dial is set to EFFECT or ASSIGN, you can use the performance edit function (→ p. 16) to control the parameters assigned to [CTRL-1] and [CTRL-2] for each effect MST FX1 and MST FX2.

Immediately after you’ve selected an effect, the most useful two parameters of that effect will be automatically selected for [CTRL-1] and [CTRL-2]. If you want to control other effect parameters rather than these, you can assign those effect parameters to [CTRL-1] and [CTRL-2].

For details, refer to the section about performance editing control (→ p. 16), and the section about the knobs (→ p. 33).

-  Noise may occur if a parameter that cannot be assigned to a knob is operated while sound is being produced.

NOTE The DRY/WET settings of MST FX 1 and MST FX 2 are handled separately from the other effect parameters. If you assign MST FX 1 or MST FX 2 DRY/WET to a knob when the [KNOB FUNCTION SELECT] dial is set to ASSIGN, the above parameter will be assigned to the knob (→ p. 33 “KNOB”).

NOTE For details on the parameters that can be assigned to knobs, refer to page 65 “2.Effect Parameters”.

About the delay time

TM RATIO (Time Ratio)

For delay effects, the actual delay time will be the delay time multiplied by the "TM RATIO."

For example,

- If "BPM SYNC": Off, "L DELAY": 0800ms, "R DELAY": 0400 ms, and "TM RATIO": 50%, then the actual delay time will be 400 ms in the left channel and 200 ms in the right channel.
- If "BPM SYNC": On, "L DELAY": ♩1/4, "R DELAY": ♩1/8, and "TM RATIO": 50%, then the actual delay time will be an eighth note in the left channel and a sixteenth note in the right channel.

Delay time when BPM SYNC is Off

If "BPM SYNC" is Off, you'll be able to set the delay time in msec units.



If the specified delay time multiplied by the "TM RATIO" would exceed the allowable range, a indication will appear at the right of the "TM RATIO" and the delay time value, and the delay time will be set to the maximum possible value.

Delay time when BPM SYNC is On

If "BPM SYNC" is On, the delay time will synchronize with the tempo specified by the [TEMPO] knob (or by an external MIDI clock). Since the tempo will follow the arpeggiator, this is useful for a live performance.

If "BPM SYNC" is On, you'll be able to set the delay time as a note value.

For example,

- If "BPM SYNC": On, "TM RATIO": 100%, L DELAY": ♩1/8, and "R DELAY BASE NOTE": ♩3/16, then the delay time will be an eighth note in the left channel and a dotted eighth note in the right channel.



If the specified delay time multiplied by the "TM RATIO" would exceed the allowable range, a indication will appear at the right of the "TM RATIO," and the delay time will be set to one half of the setting. If this would still exceed the maximum possible value, the delay time will be further shorted to 1/4, 1/8, 1/16, and so on.

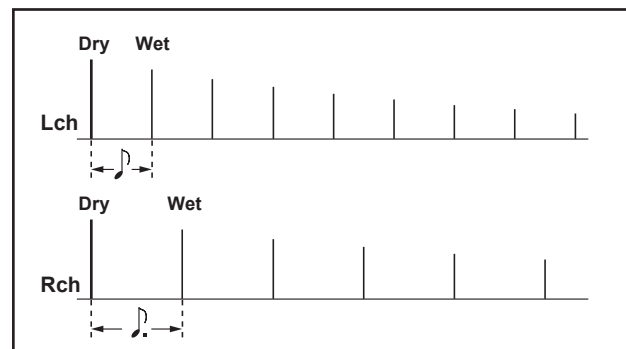

2. Effect Parameters

- [Parameter name] : These are the parameters that can be assigned to [CTRL-1] or [CTRL-2]. (→ p. 63 “Effect knob assignments”)

1. COMPRESR (Stereo Compressor)

This effect compresses the input signal to regulate the volume level and give a “punchy” effect. This is useful when applied to sounds that have a strong attack.

You can link the left and right channels or make them operate independently.

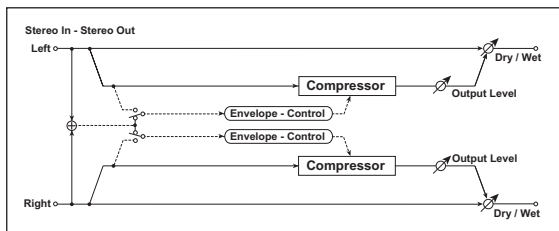

DRY/WET["DRY", 99:1... 1:99, "WET"]

Sets the balance between the effect and dry sounds.

ENV SEL (Envelope Select)[LR MIX, LR INDIV]

When L/R Mix is selected for this parameter, the left and right channels are linked to control the Limiter using the mixed signal.

With L/R individually, the left and right channels control the Limiter individually.

SENS (Sensitivity)  [001... 127]

The “SENS” parameter sets the sensitivity of the compressor. If this parameter is set to a higher value, lower level sounds will be boosted. With a higher sensitivity, the overall volume level is higher. To adjust the final volume level, use the “OUT.LEVEL” parameter.

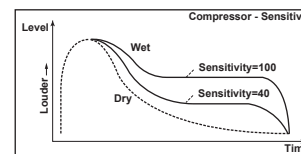

ATTACK [000.1... 500.0ms]

Sets the attack level.

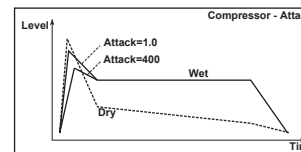

OUT.LEVEL (Output Level) [000... 127]

This parameter controls the output level.

2. FILTER (Stereo Filter)

This is a stereo filter.

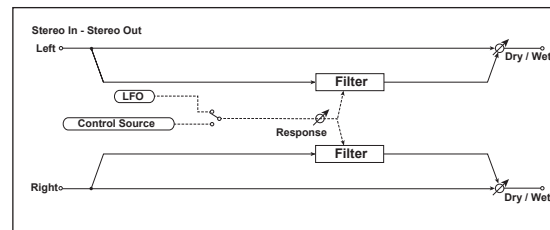

DRY/WET ["DRY", 99:1... 1:99, "WET"]

Sets the balance between the effect and dry sounds.

FLT TYPE (Filter Type)..... [LPF24 (-24dB/oct), LPF18 (-18dB/oct), LPF12 (-12dB/oct), HPF12 (-12dB/oct), BPF12 (-12dB/oct)]

Selects the filter type.
→ p. 42 “TYPE BAL (Filter1 Balance)”

CUT OFF [000...127]

Sets the filter cutoff frequency.
→ p. 42 “CUTOFF (Filter1 Cutoff)”

RESO (Resonance) [000...127]

Sets the filter resonance amount.
→ p. 42 “RESO (Filter1 Resonance)”

TRIM [000...127]

Sets the input level.

MOD SRC (Modulation Source) [LFO, CTRL]

Selects the modulation source that will control the cutoff frequency.
If you set this to LFO, the LFO will modulate the cutoff frequency.
If you set this to CTRL, the control source selected by “CTRL SRC” will control the cutoff frequency.

MOD INT (Modulation Intensity) [-63...+63]

Adjusts the depth of modulation applied by the modulation source.

RESPONSE (Modulation Response) [000...127]

Adjusts the response of the modulation effect.
A setting of 0 produces slow response.

LFO SYNC (LFO Tempo Sync) [OFF, ON]

Specifies whether the LFO cycle will synchronize to the tempo set by the [TEMPO] knob or by MIDI clock.

If this is Off, the LFO will operate at the cycle specified by “LFO Freq.”

If this is On, the LFO will synchronize to the tempo or MIDI clock.

NOTE This parameter will be displayed and can be set if “MOD INT” is LFO.

NOTE In the Global mode MIDI page “CLOCK” setting is Internal, the LFO will synchronize to the tempo specified by the [TEMPO] knob. If the setting is External, the LFO will synchronize to the MIDI clock received from an external MIDI device.

LFO FREQ (LFO Frequency) [0.01...100.0Hz]

Sets the LFO speed.

Increasing this value will result in a faster frequency.

NOTE This parameter will be displayed and can be set if “MOD SRC” is LFO and “LFO SYNC” is Off.

If this parameter is assigned to “CTRL-1,” or “CTRL-2,” switching “LFO SYNC” on will change the assignment to “SYNC.NOTE.”

SYNC.NOTE (LFO Sync Note) [8/1...1/64]

Sets the LFO frequency as a proportion of the tempo set by the [TEMPO] knob.

The length of the specified value (note value) relative to the tempo will be one cycle of the LFO. For example if this is 1/4, one cycle will occupy one quarter note.

For example if this is set to 1/4, the LFO cycle will be one beat long. If this is set to 3/4, the LFO cycle will be three beats long.

NOTE This parameter will be displayed and can be set if “MOD SRC” is LFO and “LFO SYNC” is On.

If this parameter is assigned to “CTRL-1” or “CTRL-2,” switching “LFO SYNC” Off will change the assignment to “LFO FREQ.”

LFO WAVE (LFO Waveform) [SAW, SQUARE, TRIANGLE, SINE, S&H]

Selects the LFO waveform.

NOTE This parameter will be displayed and can be set if “MOD SRC” is LFO.

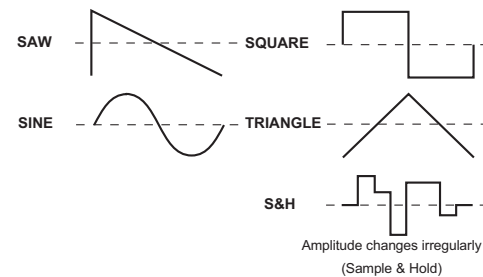

LFO.SHAPE [-63...+63]

Adjusts the shape of the LFO waveform.

NOTE This parameter will be displayed and can be set if “MOD SRC” is LFO.

KEY SYNC (LFO KeySync)[OFF, ON]

Specifies how the LFO will be reset at note-on.

NOTE This parameter will be displayed and can be set if "MOD SRC" is LFO.

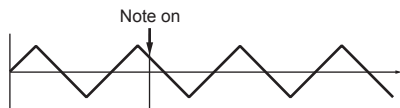

With OFF, the LFO phase will not be reset when note-on occurs.

With ON, the first note-on from a condition of no keys being pressed will reset the LFO to the phase specified by "INI.PHASE," and modulation will be applied at that phase even if subsequent note-ons occur.

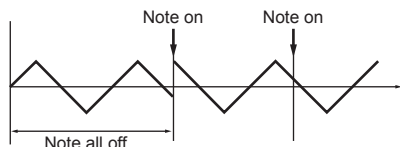

This takes effect when a note-on occurs on the global MIDI channel.

INI.PHASE (LFO Init Phase)[000...180°]

Specifies the starting position of the waveform.

With a setting of 0°, the waveform will start from its beginning at note-on.

With a setting of 180°, the waveform will start from the mid-point of its cycle at note-on.

NOTE This parameter will be displayed and can be set if "KEY SYNC" is Timbre.

CTRL SRC (Control Source)[OFF, VELOCITY...MIDI3]

Selects the control source.

The filter will be controlled by the selected source.

NOTE This parameter will be displayed and can be set if "MOD SRC" is CTRL.

Source	Explanation
OFF	Not used
VELOCITY	Velocity
P.BEND	Pitch bend
MOD.WHEEL	Modulation wheel
MIDI1	Source specified by "MIDI1" in Global mode: MIDI
MIDI2	Source specified by "MIDI2" in Global mode: MIDI
MIDI3	Source specified by "MIDI3" in Global mode: MIDI

3. BAND EQ (4Band EQ)

This is a stereo EQ for which the type can be selected independently.

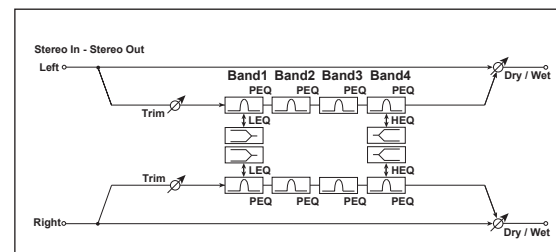

DRY/WET ["DRY", 99:1...1:99, "WET"]

Sets the balance between the effect and dry sounds.

TRIM..... [000...127]

Sets the input level of EQ.

B1 TYPE [PEAKING, SHELV LO]

Selects the EQ type of Band 1.

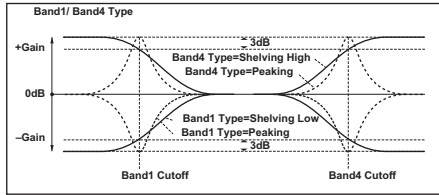

B1 FREQ (B1 Frequency)..... [20Hz...20.0kHz]

Sets the center frequency of Band 1.

B1 Q [00.5...10.0]

Sets the bandwidth of Band 1.

B1 GAIN ☺ [-18.0...+18.0dB]

Sets the gain of Band 1.

B2 FREQ (B2 Frequency)..... [20Hz...20kHz]

Sets the center frequency of Band 2.

B2 Q [00.5...10.0]

Sets the bandwidth of Band 2.

B2 GAIN ☺ [-18.0...+18.0dB]

Sets the gain of Band 2.

B3 FREQ (B3 Frequency) [20Hz...20kHz]

Sets the center frequency of Band 3.

B3 Q [00.5...10.0]

Sets the bandwidth of Band 3.

B3 GAIN ☺ [-18.0...+18.0dB]

Sets the gain of Band 3.

B4 TYPE [PEAKING, SHELV HI]

Selects the EQ type of Band 4.

B4 FREQ (B4 Frequency) [20Hz...20kHz]

Sets the center frequency of Band 4.

B4 Q [00.5...10.0]

Sets the bandwidth of Band 4.

B4 GAIN ☺ [-18.0...+18.0dB]

Sets the gain of Band 4.

4. DISTORT (Distortion)

This is a distortion effect with a three band EQ, giving you a broad range of variations.

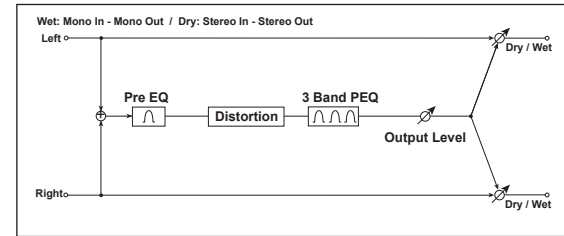

DRY/WET ["DRY", 99:1...1:99, "WET"]

Sets the balance between the effect and dry sounds.

GAIN ☺ [000...127]

Sets the degree of distortion.

PRE FREQ (Pre EQ Frequency)..... [20Hz...20.0kHz]

Sets the center frequency of Pre EQ.

PRE Q (Pre EQ Q)..... [00.5...10.0]

Sets the bandwidth of Pre EQ.

PRE GAIN (Pre EQ Gain) ☺ [-18.0...+18.0dB]

Sets the gain of Band PreEQ.

B1 FREQ (B1 Frequency) [20Hz...20kHz]

Sets the center frequency of Band 1.

B1 Q [00.5...10.0]

Sets the bandwidth of Band 1.

B1 GAIN  [-18.0...+18.0dB]

Sets the gain of Band 1.

B2 FREQ (B2 Frequency) [20Hz...20kHz]

Sets the center frequency of Band 2.

B2 Q [00.5...10.0]

Sets the bandwidth of Band 2.

B2 GAIN  [-18.0...+18.0dB]

Sets the gain of Band 2.

B3 FREQ (B3 Frequency) [20Hz...20kHz]

Sets the center frequency of Band 3.

B3 Q [00.5...10.0]

Sets the bandwidth of Band 3.

B3 GAIN  [-18.0...+18.0dB]

Sets the gain of Band 3.

OUT.LEVEL (Output Level) [000...127]

Sets the output level.

5. DECIMATR (Stereo Decimator)

This effect creates a rough sound like a cheap sampler by lowering the sampling frequency and data bit length. You can also simulate noise unique to a sampler (aliasing).

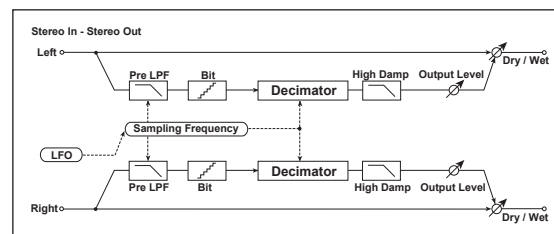

DRY/WET ["DRY", 99:1...1:99, "WET"]

Sets the balance between the effect and dry sounds.

PRE LPF [OFF, ON]

Selects whether the harmonic noise caused by a decrease in sampling frequency is generated or not.

If a sampler with a very low sampling frequency receives very high-pitched sound that could not be heard during playback, it could generate pitch noise that is unrelated to the original sound. Set "PRE LPF" to ON to prevent this noise from being generated.

If you set the "FS" to about 3kHz and set "PRE LPF" to OFF, you can create a sound like a ring modulator.

HI DAMP [000...100%]

Sets the ratio of cut from the high range.

FS  [01.0...48.0kHz]

Sets the sampling frequency.

BIT  [04...24bit]

Sets the data bit length.

If you set a smaller value for the "BIT" parameter, the sound may be distorted.

NOTE The volume level may also be changed. Use "OUT.LEVEL" to adjust the level.

OUT.LEVEL (Output Level) [000...127]

Sets the output level.

FS.MOD.INT (Fs Modulation Intensity) [-63...+63]
Sets the depth of sampling frequency LFO modulation.

LFO SYNC (LFO Tempo Sync)[OFF, ON]
Specifies whether the LFO cycle will synchronize to the tempo specified by the [TEMPO] knob or MIDI clock. → p. 66 “LFO SYNC (LFO Tempo Sync)”

LFO FREQ (LFO Frequency)  [0.01...100.0Hz]
Sets the LFO speed.

NOTE This parameter will be displayed and can be set if “MOD SRC” is LFO and “LFO SYNC” is Off. → p. 66 “LFO FREQ (LFO Frequency)”

SYNC.NOTE (LFO Sync Note)  [8/1...1/64]
Sets the LFO frequency as a proportion of the tempo set by the [TEMPO] knob.

NOTE This parameter will be displayed and can be set if “LFO SYNC” is ON. → p. 66 “SYNC.NOTE (LFO Sync Note)”

LFO WAVE (LFO Waveform) [SAW, SQUARE, TRIANGLE, SINE, S&H]
Selects the LFO waveform.
→ p. 66 “LFO WAVE (LFO Waveform)”

LFO.SHAPE[-63...+63]
Adjusts the shape of the LFO waveform.
→ p. 66 “LFO.SHAPE”

KEY SYNC (LFO KeySync)[OFF, ON]
Specifies whether the LFO will be reset at note-on.

NOTE This parameter will be displayed and can be set if “MOD SRC” is LFO. → p. 67 “KEY SYNC (LFO KeySync)”

INI.PHASE (LFO Init Phase)[000...180°]
Specifies the starting position of the waveform.

NOTE This parameter will be displayed and can be set if “KEY SYNC” is ON.

6. DELAY (Stereo Delay)

This is a stereo delay, and can be used as a cross-feedback delay effect in which the delay sounds cross over between the left and right by changing the feedback routing.

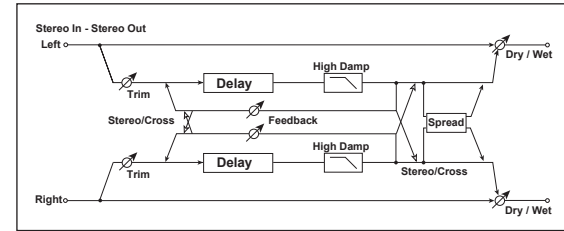



DRY/WET ["DRY", 99:1...1:99, "WET"]
Sets the balance between the effect and dry sounds.

TYPE [STEREO, CROSS]
Selects the delay type.
With the STEREO setting, this will be a conventional stereo delay.
With the CROSS setting, this will be a cross-feedback delay in which the delay sound bounces between left and right.

BPM SYNC (DelayTime Tempo Sync)[OFF, ON]
Specifies whether the delay time will be synchronized.
If this is On, the delay time will synchronize to the tempo or MIDI clock.

TM RATIO  [BPM SYNC OFF: 000.5...400.0% (OVER) /BPM SYNC ON: 012.5...400.0% (OVER)]

Sets each delay time as a proportion relative to the “L DELAY,” and “R DELAY” values.
The available range will depend on whether “BPM SYNC” is ON or OFF.
For example if “TM RATIO” is 50%, “L DELAY” is 500 msec, and “R DELAY” is 1200 msec, the delay times will be 250 msec, 500 msec, and 600 msec respectively.

 If the delay times in conjunction with the “TM RATIO” setting exceed the limit, “TM RATIO” will indicate .

L DELAY, R DELAY (L, R Delay Time) [000...1400ms, 1/64... 1/1]
These set the left and right channel delay times.
If “BPM SYNC” is Off, these delay times are set in msec units.
If “BPM SYNC” is On, these delay times are set as a timing resolution relative to the tempo specified by the [TEMPO] knob or MIDI clock.

FEEDBACK [000...127]

Sets the amount of feedback for the left and right channels.
The amount of feedback for the right channel is linked with the proportion of the left and right delay times so that the decay times of the left and right channels will stay the same.

HI DAMP [000...100%]

Sets the damping amount in the high range.

TRIM [000...127]

Sets the input level.

SPREAD [000...127]

Sets the width of the stereo image of the effect sound.
The stereo image is widest with a value of 127, and the effect sound of both channels is output from the center with a value of 0.

7. LCR.DELAY (L/C/R Delay)

This multitap delay outputs three Tap signals to the left, center, and right respectively. You can also adjust the left and right spread of the delay sound.

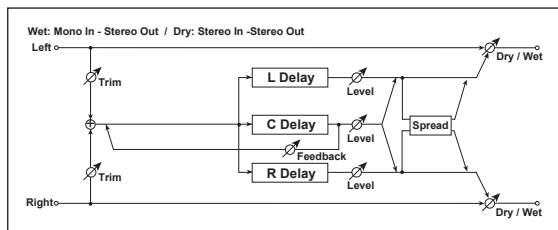

DRY/WET ["DRY", 99:1...1:99, "WET"]

Sets the balance between the effect and dry sounds.

BPM SYNC (DelayTime Tempo Sync) [OFF, ON]

Specifies whether the delay time will be synchronized.
If this is On, the delay time will synchronize to the tempo or MIDI clock.

TM RATIO [BPM SYNC OFF: 000.5...400.0% (OVER) /BPM SYNC ON: 012.5...400.0% (OVER)]

Sets each delay time as a proportion relative to the "L DELAY," "C DELAY," and "R DELAY" values.
→ p. 70 "TM RATIO"

L DELAY, C DELAY, R DELAY (L, C, R Delay Time) [0000...1400ms, 1/64... 1/1]

These set the L, C, and R delay times.
The delay time is determined by these settings and the "TM RATIO" value.
→ p. 70 "L DELAY, R DELAY (L, R Delay Time)"

L LEVEL, C LEVEL, R LEVEL (L, C, R Delay Level) [000...127]

These adjust the output level of the L, C, and R delays.

C FEEDBK (C Feedback) [000...127]

Sets the feedback amount of TapC.

TRIM..... [000...127]

Sets the input level.

SPREAD..... [000...127]

Sets the width of the stereo image of the effect sound.
The stereo image is widest with a value of 127, and the effect sound of both channels is output from the center with a value of 0.

8. PAN.DELAY (Stereo Auto Panning Delay)

This is a stereo delay that uses an LFO to pan the delay sound between left and right.

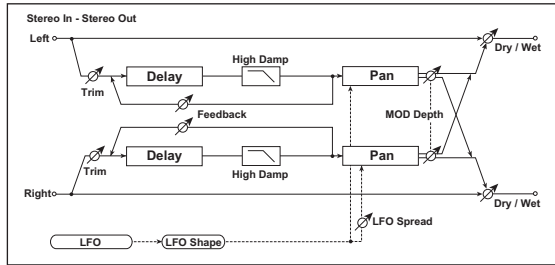

DRY/WET["DRY", 99:1...1:99, "WET"]

Sets the balance between the effect and dry sounds.

BPM SYNC (DelayTime Tempo Sync)[OFF, ON]

→ p. 70 "BPM SYNC (DelayTime Tempo Sync)"

TM RATIO[BPM SYNC OFF: 000.5...400.0% (OVER)/
BPM SYNC ON: 012.5...400.0% (OVER)]

→ p. 70 "TM RATIO"

L DELAY, R DELAY (L, R Delay Time) [000...1400ms, 1/64... 1/1]

→ p. 70 "L DELAY, R DELAY (L, R Delay Time)"

FEEDBACK [000...127]

→ p. 71 "FEEDBACK"

MOD.DEPTH [000...127]

Sets the depth of modulation.

LFO SYNC (LFO Tempo Sync)[OFF, ON]

Specifies whether the LFO cycle will be synchronized with the tempo specified by the [TEMPO] knob or MIDI clock.

→ p. 66 "LFO SYNC (LFO Tempo Sync)"

LFO FREQ (LFO Frequency) [0.01...100.0Hz]

Sets the LFO speed.

→ p. 66 "LFO FREQ (LFO Frequency)"

SYNC.NOTE (LFO Sync Note) [8/1...1/64]

Sets the LFO frequency as a proportion of the tempo set by the [TEMPO] knob.

NOTE This parameter will be displayed and can be set if "LFO Sync" is On.

→ p. 66 "SYNC.NOTE (LFO Sync Note)"

LFO WAVE (LFO Waveform)..... [SAW, SQUARE, TRIANGLE, SINE, S&H]

Selects the LFO waveform.

→ p. 66 "LFO WAVE (LFO Waveform)"

LFO.SHAPE [-63...+63]

→ p. 66 "LFO.SHAPE"

KEY SYNC (LFO Key Sync)[OFF, ON]

Specifies whether the LFO will be reset by note-on.

→ p. 67 "KEY SYNC (LFO KeySync)"

INI.PHASE (LFO Init Phase) [000...180°]

Sets the starting location of the waveform.

NOTE This parameter will be displayed and can be set if "KEY SYNC" is ON.

→ p. 67 "INI.PHASE (LFO Init Phase)"

LFO SPRD (LFO Spread)[-180...+180°]

Sets the phase difference between the left and right channels.

HI DAMP [000...100%]

Sets the damping amount in the high range.

TRIM..... [000...127]

Sets the input level.

9. MOD.DELAY (Stereo Modulation Delay)

This is a stereo modulation delay.

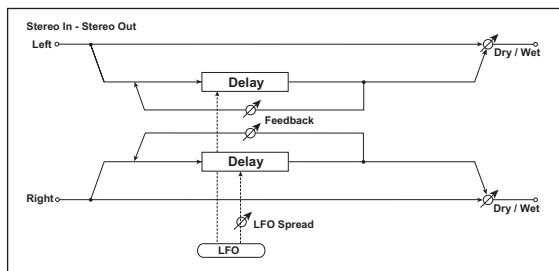

DRY/WET["DRY", 99:1...1:99, "WET"]

Sets the balance between the effect and dry sounds.

BPM SYNC (Delay Time Tempo Sync).....[OFF, ON]

→ p. 70 "BPM SYNC (DelayTime Tempo Sync)"

TM RATIO [BPM SYNC OFF: 000.5...400.0% (OVER) /BPM SYNC ON: 012.5...400.0% (OVER)]

→ p. 70 "TM RATIO"

L DELAY, R DELAY (L, R Delay Time) [000...1400ms, 1/64... 1/1]

→ p. 70 "L DELAY, R DELAY (L, R Delay Time)"

FEEDBACK [000...127]

→ p. 71 "FEEDBACK"

MOD.DEPTH [000...127]

Sets the depth of LFO modulation.

LFO FREQ (LFO Frequency) [0.01...100.0Hz]

Sets the LFO speed. Increasing this value will result in a faster frequency.

LFO SPRD (LFO Spread)..... [-180...180°]

Sets the phase difference between the left and right channels.

10. TAPE.ECHO

This effect simulates a tape echo unit. The distortion and tonal change typical of magnetic tape are also reproduced.

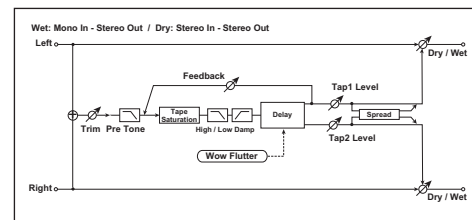

DRY/WET ["DRY", 99:1...1:99, "WET"]

Sets the balance between the effect and dry sounds.

BPM SYNC (DelayTime Tempo Sync).....[OFF, ON]

→ p. 70 "BPM SYNC (DelayTime Tempo Sync)"

TM RATIO [BPM SYNC OFF: 000.5...400.0% (OVER) /BPM SYNC ON: 012.5...400.0% (OVER)]

→ p. 70 "TM RATIO"

TAP1 DLY, TAP2 DLY (Tap1, Tap2 Delay Time)

..... [0000...1400ms, 1/64... 1/1]

Sets the delay times for Tap1 and Tap2.

→ p. 70 "L DELAY, R DELAY (L, R Delay Time)"

TAP1 LVL, TAP2 LVL(Tap1Level, Tap2 Level) [000...127]

Sets the Tap1 output level and Tap2 output level.

FEEDBACK [000...127]

Sets the Tap1 feedback amount.

HI DAMP [000...100%]

Sets the damping amount in the high range.

LO DAMP [000...100%]

Sets the damping amount in the low range.

TRIM..... [000...127]

Sets the input level.

SATURATN (Tape Saturation)  [000...127]

Sets the distortion amount.

WOW.FREQ (Wow Flutter Frequency) [0.01...100.0Hz]

Sets the frequency at which pitch variation will occur in Hz steps.

WOW.DEPTH (Wow Flutter Depth) [000...127]

Sets the depth of pitch variation.

PRE TONE [000...127]

Sets the tone of the input.

SPREAD [000...127]

Sets the width of the stereo image of the effect sound.

→ p. 71 "SPREAD"

11. CHORUS (Stereo Chorus)

This effect adds thickness and warmth to the sound by modulating the delay time of the input signal. You can add spread to the sound by offsetting the phase of the left and right LFOs from each other.

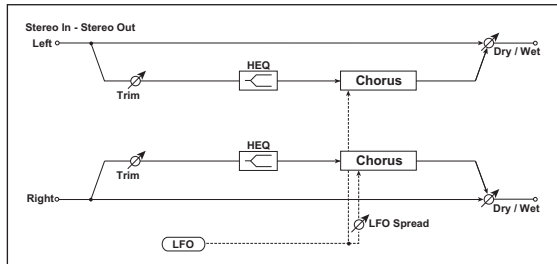

DRY/WET ["DRY", 99:1...1:99, "WET"]

Sets the balance between the effect and dry sounds.

MOD.DEPTH (Modulation Depth)  [000...127]

Sets the depth of LFO modulation.

LFO FREQ (LFO Frequency)  [0.01...100.0Hz]

Sets the LFO speed. Increasing this value will result in a faster frequency.

LFO SPRD (LFO Spread) [-180...180°]

Sets the LFO phase difference between the left and right.

PRE DLY L, PRE DLY R (Pre Delay L, Pre Delay R) [00.0...50.0ms]

Sets the delay times for the left and right channels.

TRIM [000...127]

Sets the input level.

HI.EQ.GAIN (High EQ Gain) [-15.0...+15.0dB]

Sets the gain of High EQ.

12. FLANGER (Stereo Flanger)

This effect gives a significant swell and movement of pitch to the sound. It is more effective when applied to a sound with a lot of harmonics. This is a stereo flanger.

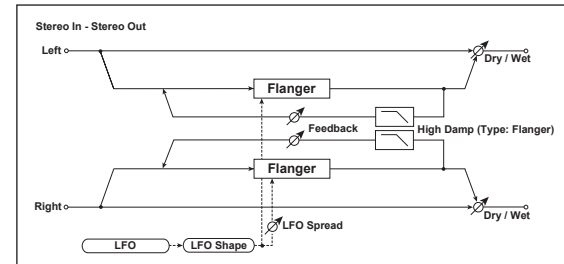

DRY/WET ["DRY", 99:1...1:99, "WET"]

Sets the balance between the effect and dry sounds.

DELAY  [00.0...30.0ms]

Sets the delay time in millisecond steps.

MOD.DEPTH (Modulation Depth)  [000...127]

Sets the depth of LFO modulation.

FEEDBACK  [000...127]

Sets the amount of feedback for the left and right channels.

PHASE [+,-]

This switches the phase of the output and feedback.

LFO SYNC (LFO Tempo Sync) [OFF, ON]

Specifies whether the LFO cycle will be synchronized with the tempo specified by the [TEMPO] knob or MIDI clock.

→ p. 66 “LFO SYNC (LFO Tempo Sync)”

LFO FREQ (LFO Frequency)  [0.01...100.0Hz]

Sets the LFO speed.

→ p. 66 “LFO FREQ (LFO Frequency)”

SYNC.NOTE (LFO Sync Note)  [8/1...1/64]

Sets the LFO frequency as a proportion of the tempo set by the [TEMPO] knob. → p. 66 “SYNC.NOTE (LFO Sync Note)”

NOTE This parameter will be displayed and can be set if “LFO SYNC” is ON.

LFO WAVE (LFO Waveform) [SAW, SQUARE, TRIANGLE, SINE, S&H]

Selects LFO Waveform. → p. 66 “LFO WAVE (LFO Waveform)”

LFO.SHAPE [-63...+63]

→ p. 66 “LFO.SHAPE”

KEY SYNC (LFO KeySync) [OFF, ON]

Specifies whether the LFO will be reset by note-on.

→ p. 67 “KEY SYNC (LFO KeySync)”

INI.PHASE (LFO Init Phase) [000...180°]

Sets the starting location of the waveform. → p. 67 “INI.PHASE (LFO Init Phase)”

NOTE This parameter will be displayed and can be set if “KEY SYNC” is ON.

LFO SPRD (LFO Spread)..... [-180...+180°]

Sets the LFO phase difference between the left and right channels.

HI DAMP (High Damp) [000...100%]

Sets the feedback damping amount in the high range.

13. VIBRATO (Stereo Vibrato)

This effect causes the pitch of the input signal to shimmer. Using the Auto-Fade allows you to increase or decrease the shimmering speed.

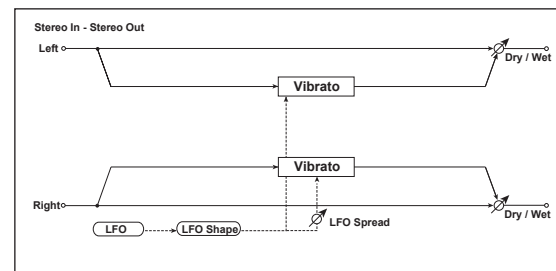

DRY/WET ["DRY", 99:1...1:99, "WET"]

Sets the balance between the effect and dry sounds.

MOD.DEPTH (Modulation Depth)  [000...127]

Sets the depth of LFO modulation.

LFO SYNC (LFO Tempo Sync) [OFF, ON]

Specifies whether the LFO cycle will be synchronized with the tempo specified by the [TEMPO] knob or MIDI clock.

→ p. 66 “LFO SYNC (LFO Tempo Sync)”

LFO FREQ (LFO Frequency)  [0.01...100.0Hz]

Sets the LFO speed.

→ p. 66 “LFO FREQ (LFO Frequency)”

SYNC.NOTE (LFO Sync Note)  [8/1...1/64]

Sets the LFO frequency as a proportion of the tempo set by the [TEMPO] knob.

NOTE This parameter will be displayed and can be set if “LFO SYNC” is ON.

→ p. 66 “SYNC.NOTE (LFO Sync Note)”

LFO WAVE (LFO Waveform)..... [SAW, SQUARE, TRIANGLE, SINE, S&H]

Selects the LFO waveform.

→ p. 66 “LFO WAVE (LFO Waveform)”

LFO SHAPE[-63...+63]
 → p. 66 "LFO.SHAPE"

KEY SYNC (LFO KeySync)[OFF, ON]
 Specifies whether the LFO will be reset by note-on.
 → p. 67 "KEY SYNC (LFO KeySync)"

INI.PHASE (LFO Init Phase)[000...180°]
 Sets the starting location of the waveform.
NOTE This parameter will be displayed and can be set if "KEY SYNC" is ON.
 → p. 67 "INI.PHASE (LFO Init Phase)"

LFO.SPRD (LFO Spread)[-180...+180°]
 Sets the LFO phase difference between the left and right channels.

14. PHASER (Stereo Phaser)

This effect creates a swell by shifting the phase. You can add spread to the sound by offsetting the phase of the left and right LFOs from each other.

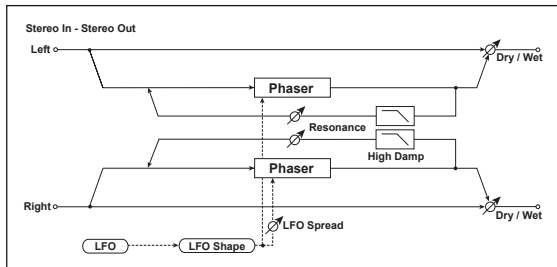

DRY/WET["DRY", 99:1...1:99, "WET"]
 Sets the balance between the effect and dry sounds.

TYPE.....[BLUE, U_VB]
 Selects the phaser type.

MANUAL ☒ [000...127]
 Sets the frequency to which the effect is applied.

MOD.DEPTH (Modulation Depth) ☒ [000...127]
 Sets the depth of LFO modulation.

RESO (Resonance) ☒ [000...127]
 Sets the resonance amount.

PHASE..... [+,-]
 Switches the phase of the output and feedback.

LFO SYNC (LFO Tempo Sync)[OFF, ON]
 Specifies whether the LFO cycle will be synchronized with the tempo specified by the [TEMPO] knob or MIDI clock.
 → p. 66 "LFO SYNC (LFO Tempo Sync)"

LFO FREQ (LFO Frequency) ☒ [0.01...100.0Hz]
 Sets the LFO speed.
 → p. 66 "LFO FREQ (LFO Frequency)"

SYNC.NOTE (LFO Sync Note) ☒ [8/1...1/64]
 Sets the LFO frequency as a proportion of the tempo set by the [TEMPO] knob.
NOTE This parameter will be displayed and can be set if "LFO SYNC" is ON.
 → p. 66 "SYNC.NOTE (LFO Sync Note)"

LFO WAVE (LFO Waveform)..... [SAW, SQUARE, TRIANGLE, SINE, S&H]
 Selects the LFO waveform.
 → p. 66 "LFO WAVE (LFO Waveform)"

LFO.SHAPE [-63...+63]
 → p. 66 "LFO.SHAPE"

KEY SYNC (LFO KeySync).....[OFF, ON]
 Specifies whether the LFO will be reset by note-on.
 → p. 67 "KEY SYNC (LFO KeySync)"

INI.PHASE (LFO Init Phase) [000...180°]
 Sets the starting location of the waveform.
NOTE This parameter will be displayed and can be set if "KEY SYNC" is ON.
 → p. 67 "INI.PHASE (LFO Init Phase)"

LFO SPRD (LFO Spread).....[-180...+180°]

Sets the LFO phase difference between the left and right channels.

HI DAMP [000...100%]

Sets the feedback damping amount in the high range.

15. TREMOLO (Stereo Tremolo)

This effect modulates the volume level of the input signal. The effect is stereo, and offsetting the LFO of the left and right phases from each other produces a tremolo effect between left and right.

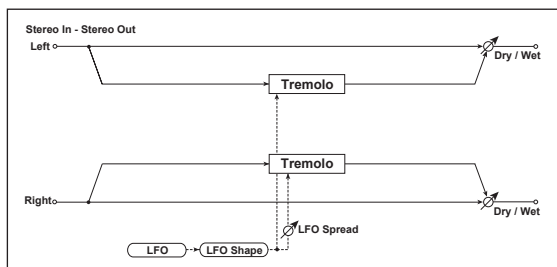

DRY/WET["DRY", 99:1...1:99, "WET"]

Sets the balance between the effect and dry sounds.

MOD.DEPTH (Modulation Depth) ▣ [000...127]

Sets the depth of LFO modulation.

LFO SYNC (LFO Tempo Sync) [OFF, ON]

Specifies whether the LFO cycle will be synchronized with the tempo specified by the [TEMPO] knob or MIDI clock.

→ p. 66 "LFO SYNC (LFO Tempo Sync)"

LFO FREQ (LFO Frequency) ▣ [0.01...100.0Hz]

Sets the LFO speed.

→ p. 66 "LFO FREQ (LFO Frequency)"

SYNC.NOTE (LFO Sync Note) ▣ [8/1...1/64]

Sets the LFO frequency as a proportion of the tempo set by the [TEMPO] knob.

NOTE This parameter will be displayed and can be set if "LFO SYNC" is ON.

→ p. 66 "SYNC.NOTE (LFO Sync Note)"

LFO WAVE (LFO Waveform)..... [SAW, SQUARE, TRIANGLE, SINE, S&H]

Selects the LFO waveform.

→ p. 66 "LFO WAVE (LFO Waveform)"

LFO.SHAPE [-63...+63]

→ p. 66 "LFO.SHAPE"

KEY SYNC (LFO KeySync)..... [OFF, ON]

Specifies whether the LFO will be reset by note-on.

→ p. 67 "KEY SYNC (LFO KeySync)"

INI.PHASE (LFO Init Phase) [000...180°]

Sets the starting location of the waveform.

NOTE This parameter will be displayed and can be set if "KEY SYNC" is ON.

→ p. 67 "INI.PHASE (LFO Init Phase)"

LFO SPRD (LFO Spread).....[-180...+180°]

Sets the LFO phase difference between the left and right channels.

16. RING MOD (Stereo Ring Modulator)

This effect creates a metallic sound by applying the oscillators to the input signal. Use the LFO or Dynamic Modulation to modulate the oscillator to create a radical modulation. Matching the oscillator frequency with a note number will produce a ring modulation effect in specific key ranges.

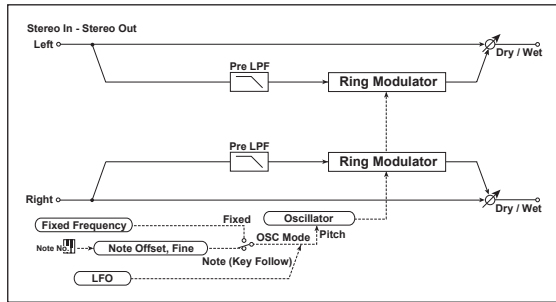

DRY/WET["DRY", 99:1...1:99, "WET"]

Sets the balance between the effect and dry sounds.

OSC MODE[FIXED, NOTE]

Switching between specifying the oscillator frequency and using a note number.

If this is set to NOTE, the oscillator frequency will track the note of the input signal.

FIXD.FREQ (Fixed Frequency) [0Hz...12.0kHz]

This parameter sets the oscillator frequency when "OSC MODE" is set to FIXED.



If this parameter is assigned to "CTRL-1," or "CTRL-2," setting "OSC MODE" to NOTE will switch the assignment to NOTE.OFST.

NOTE.OFST (Note Offset) [-48...+48]

Sets the pitch difference from the original note in semitone steps when "OSC MODE" is set to NOTE.

NOTE.FINE..... [-100...+100]

Sets the pitch difference from the original note in cent steps when "OSC MODE" is set to NOTE.

NOTE By setting "NOTE.OFST" and "Note.Fine" so that the oscillator frequency will track the note that is input, you can produce a ring modulator effect with a correct scale.

OSC WAVE (OSC Waveform) [SAW, TRIANGLE, SINE]

Selects the oscillator waveform.

LFO INT (LFO Intensity) [-63...+63]

Sets the depth of LFO modulation.

LFO SYNC (LFO Tempo Sync)[OFF, ON]

Specifies whether the LFO cycle will be synchronized with the tempo specified by the [TEMPO] knob or MIDI clock. → p. 66 "LFO SYNC (LFO Tempo Sync)"

LFO FREQ (LFO Frequency) [0.01...100.0Hz]

Sets the LFO speed. → p. 66 "LFO FREQ (LFO Frequency)"

SYNC.NOTE (LFO Sync Note) [8/1...1/64]

Sets the LFO frequency as a proportion of the tempo set by the [TEMPO] knob. → p. 66 "SYNC.NOTE (LFO Sync Note)"

NOTE This parameter will be displayed and can be set if "LFO SYNC" is ON.

LFO WAVE (LFO Waveform)..... [SAW, SQUARE, TRIANGLE, SINE, S&H]

Selects the LFO waveform.

→ p. 66 "LFO WAVE (LFO Waveform)"

LFO.SHAPE [-63...+63]

→ p. 66 "LFO.SHAPE"

KEY SYNC (LFO KeySync).....[OFF, ON]

Specifies whether the LFO will be reset by note-on.

→ p. 67 "KEY SYNC (LFO KeySync)"

INI.PHASE (LFO Init Phase) [000...180°]

Sets the starting location of the waveform.

NOTE This parameter will be displayed and can be set if "KEY SYNC" is ON.

→ p. 67 "INI.PHASE (LFO Init Phase)"

PRE LPF..... [000...127]

This parameter enables you to set the damping amount of the high range sound input to the ring modulator. If the input sound contains lots of harmonics, the effect may sound dirty. In this case, cut a certain amount of high range.

17. GRAIN.SFT (Grain Shifter)

This effect samples extremely brief fragments of the sound at a specified interval, and plays them as a loop. This is effective when used on external input sounds that are constantly changing.

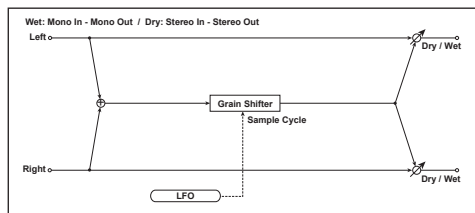

DRY/WET["DRY", 99:1...1:99, "WET"]

Sets the balance between the effect and dry sounds.

BPM SYNC (Duration Tempo Sync) [OFF, ON]

Specifies whether playback of the looped waveform will be synchronized. If this is ON, the looped waveform will play in synchronization with the tempo or MIDI clock.

TM RATIO [BPM SYNC OFF: 000.5...400% (OVER)/BPM SYNC ON: 012.5...400% (OVER)]

This specifies the length of the looped waveform relative to the "DURATION" value.

DURATION [000...350ms, 1/64... 1/1]

Sets the duration of the grain.

The length of the waveform is determined by this setting and the "TimeRatio" setting.

If "BPM SYNC" is OFF, this is set in msec units.

If "BPM SYNC" is ON, this is set as a timing resolution relative to the tempo specified by the [TEMPO] knob or MIDI clock.



If the "DURATION" and "TM RATIO" settings exceed the limit, an indication of will appear for the "TM RATIO."

LFO SYNC (LFO Tempo Sync) [OFF, ON]

Specifies whether the LFO cycle will be synchronized with the tempo specified by the [TEMPO] knob or MIDI clock.
→ p. 66 "LFO SYNC (LFO Tempo Sync)"

LFO FREQ (LFO Frequency) [0.01...100.0Hz]

If "LFO SYNC" is Off, this specifies the cycle at which the waveform is switched in Hz units.

The waveform length specified by "DURATION" will play as a loop, and the waveform will switch at each cycle of the LFO.

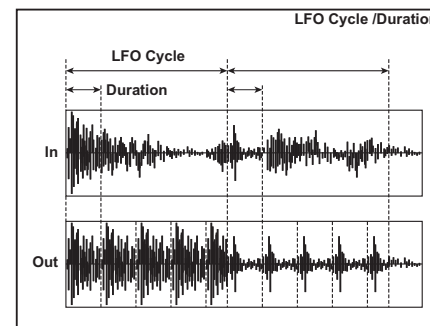

If this parameter is assigned to "CTRL-1" or "CTRL-2," switching "BPM SYNC" On will change the assignment to "SYNC.NOTE."

SYNC.NOTE (LFO Sync Note) [8/1...1/64]

Sets the LFO frequency as a proportion of the tempo set by the [TEMPO] knob.

NOTE This parameter will be displayed and can be set if "LFO SYNC" is ON.
→ p. 66 "SYNC.NOTE (LFO Sync Note)"

KEY SYNC (LFO KeySync) [OFF, ON]

Specifies whether the LFO will be reset by note-on.

→ p. 67 "KEY SYNC (LFO KeySync)"

INI.PHASE (LFO Init Phase) [000...180°]

Sets the starting location of the waveform.

NOTE This parameter will be displayed and can be set if "KEY SYNC" is ON.
→ p. 67 "INI.PHASE (LFO Init Phase)"

MIDI

1. Using the microKORG XL+ with other MIDI devices (MIDI)

Here you can adjust MIDI-related settings for the **microKORG XL+**. MIDI stands for Musical Instrument Digital Interface, and is a world-wide standard for exchanging various types of musical data between electronic musical instruments and computers. When MIDI cables are used to connect two or more MIDI devices, performance data can be exchanged between the devices, even if they were made by different manufacturers. The **microKORG XL+** lets you assign control change numbers to the major parameters that affect the sound, and control these parameters from an external MIDI sequencer while you play the tone generator. You can also use the assigned knobs [1]–[3] or keys to transmit these control changes to control an external MIDI device.

You can synchronize the **microKORG XL+**'s arpeggiator, LFO rate, or the delay time of the delay effect to the MIDI Clock of an external MIDI sequencer.

Connecting MIDI devices/computers

Controlling an external MIDI tone generator from the microKORG XL+

When you want to use the **microKORG XL+**'s keyboard, controllers, and arpeggiator etc. to play an external MIDI tone generator, use a MIDI cable to connect the **microKORG XL+**'s MIDI OUT connector to the MIDI IN connector of the external MIDI tone generator.

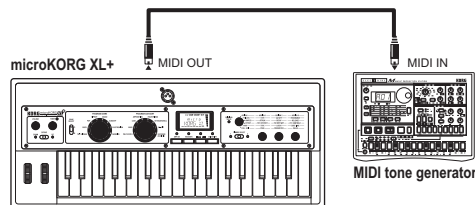

Controlling the microKORG XL+'s tone generator from an external MIDI device

When you want to play or control the **microKORG XL+**'s tone generator from an external MIDI keyboard or sequencer etc., use a MIDI cable to connect the MIDI OUT connector of the external MIDI device to the MIDI IN connector of the **microKORG XL+**.

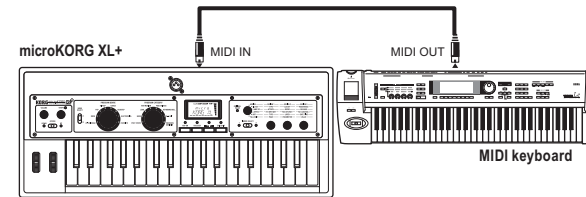

Controlling two or more external MIDI tone generators from the microKORG XL+

You can also use a MIDI patch bay to control multiple MIDI devices.

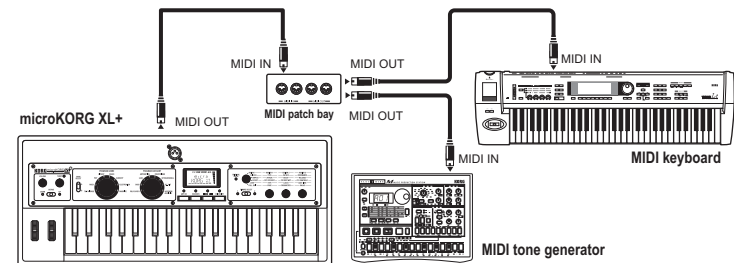

Connecting an external MIDI sequencer or computer etc.

If you want to record your performance on the **microKORG XL+**'s keyboard into your external MIDI sequencer/computer (via a MIDI interface), or use the **microKORG XL+** as a combination of controller keyboard and MIDI sound module, or use the Editor/Librarian software included with the **microKORG XL+**, then you'll need to connect the **microKORG XL+**'s MIDI OUT and MIDI IN connectors to the MIDI IN and MIDI OUT connectors respectively of your external MIDI sequencer or computer.

 MIDI interface devices may be unable to transmit or receive the **microKORG XL+**'s MIDI exclusive messages.

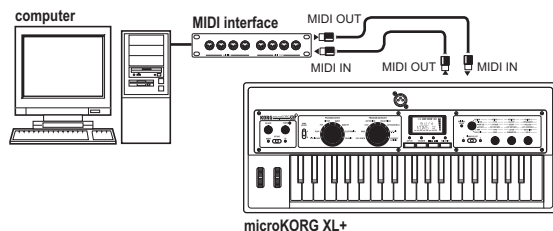

Connecting the **microKORG XL+** to your computer via USB

As an alternate way of connecting the **microKORG XL+** to your computer in the situations described above, you can use a USB cable if your computer has a USB connector. Since a USB connection sends the data faster than when using MIDI cables and a MIDI interface, we recommend a USB connection if you're going to be using the PC editor software.

NOTE In order to use a USB connection, you must install the Korg USB-MIDI driver in your computer. Download the Korg USB-MIDI driver from the Korg website, and install it as directed by the accompanying documentation.

 If either the MIDI connection or the USB connection does not work, you should also check the "ROUTING" setting (→ p. 59) in the MIDI page.

MIDI-related settings

MIDI channel setting

In order to exchange data with a connected external MIDI device, you must set the **microKORG XL+**'s MIDI channel to match the MIDI channel of the external MIDI device.

Setting the **microKORG XL+**'s MIDI channel

1. Use knob [1] to select the MIDI page.
2. Use knob [2] to select "MIDI CH," and then use knob [3] to specify the MIDI channel.
3. Set the MIDI channel of the connected external MIDI device.

NOTE For details on how to set the MIDI channel of the external MIDI device, refer to the owner's manual of the connected device.

Using the **microKORG XL+** as a multi-timbral sound module

You can specify a different MIDI channel for each of the **microKORG XL+**'s two timbres and use it as a multi-timbral sound module from a connected external MIDI sequencer.

1. Use knob [1] to select the COMMON page.
2. Use knob [2] to select "VOIC.MODE," and then use knob [3] to select "MULTI."
3. Specify the MIDI channel for timbre 2.
After you've set VOIC.MODE to MULTI, you can turn knob [2] to select the "T2.MIDICH" parameter.
Use knob [3] to specify the MIDI channel for timbre 2.
4. To set the MIDI channel for timbre 1, select the MIDI page "MIDI CH" parameter, and use knob [3].
5. Set the MIDI channel of the connected external MIDI device.

GLOBAL "POSITION" setting

The **microKORG XL+**'s GLOBAL "POSITION" lets you specify how MIDI IN/OUT will be internally routed. This will affect how the MIDI data will be affected by the "TRANSPOS," "VEL.CURVE," and arpeggiator settings.

- Normally when controlling an external MIDI tone generator from the **microKORG XL+**, you will set "POSITION" to POST KBD. The various settings listed above will affect the MIDI data that is transmitted. The received data will be processed as "TRANSPOS": 0, "VEL.CURVE": 4.

- Normally when controlling the **microKORG XL+**'s tone generator from an external MIDI device, you will set "POSITION" to PRE TG. The various settings listed above will affect the MIDI data that is received. The transmitted data will be processed as "TRANSPOS": 0 and "VEL.CURVE": 4.

"MIDI FILTER" settings

The MIDI FLT page setting specifies whether program change, pitch bend, control change, and system exclusive messages will be transmitted or received. (→ p. 60)

Virtual patch modulation source settings

You can assign three different MIDI control messages (MIDI 1, 2, 3) as virtual patch modulation sources. Make the desired assignments in the PATCH page (→ p. 60), and then select MIDI1 or MIDI2 etc. as the virtual patch source for the virtual patch settings (PATCH1–PATCH6). This lets you control modulation via MIDI.

The modulation source "FC.MOD.SRC" of the cutoff frequency of the vocoder's carrier band-pass filters can also be controlled via MIDI; simply select MIDI 1, 2, or 3 as the virtual patch modulation source.

"CONTROL CHANGE" settings

You can assign control change numbers to the major parameters that affect the sound, and use an external MIDI device to perform the same operations as when the knobs and keys of the **microKORG XL+** are operated. Conversely, you can operate the **microKORG XL+**'s knobs and keys to control an external MIDI device. Use the CC MAP page to assign control change messages to parameters. (→ p. 61)

MIDI "LOCAL" setting when connecting an external MIDI sequencer or computer

If notes are sounding doubled when the **microKORG XL+** is connected to an external MIDI sequencer or computer, turn the Local setting off (MIDI page "LOCAL" OFF). (→ p. 59)

If the **microKORG XL+** is connected to an external MIDI sequencer or computer, and the Echo Back setting of the external MIDI sequencer or computer is turned on while the **microKORG XL+**'s Local Control setting is also on, the performance data generated when you play the **microKORG XL+**'s keyboard will be sent to the external MIDI sequencer, and will also be echoed-back to sound the **microKORG XL+**'s tone generator a second time. To prevent each note from being sounded twice, once directly from

the keyboard and once from the echoed-back note, you must turn the **microKORG XL+**'s Local Control setting off.

Recording the MIDI output from the microKORG XL+'s arpeggiator onto an external MIDI sequencer or computer

Connect and setting

Connect the **microKORG XL+**'s MIDI OUT connector to the MIDI IN connector of your external MIDI sequencer / computer, and connect the **microKORG XL+**'s MIDI IN connector to the MIDI OUT connector of your external MIDI sequencer / computer. Then turn the **microKORG XL+**'s Local Control off (MIDI page "LOCAL" OFF), and turn on the echo back setting of your external MIDI sequencer / computer.

Recording the note data from the arpeggiator onto an external MIDI sequencer / computer

Set the **microKORG XL+**'s GLOBAL page "POSITION" to POST KBD. Turn on the **microKORG XL+**'s arpeggiator (ARPEGGIATOR [ARP ON] button lit), play the keyboard, and record the note data on your external MIDI sequencer / computer. If the GLOBAL page "POSITION" is set to POST KBD, the MIDI note data produced by the arpeggiator will be output from the **microKORG XL+**, and recorded. Turn the **microKORG XL+**'s arpeggiator off during playback.

Synchronizing the arpeggiator

The MIDI page "CLOCK" setting specifies whether the **microKORG XL+**'s arpeggiator will be the master (the controlling device) or slave (the controlled device).

NOTE For information on synchronization-related settings of your external MIDI device, refer to the manual of your device.

Using the microKORG XL+ as master and the external MIDI device as slave

Connect the **microKORG XL+**'s MIDI OUT connector to your external MIDI device's MIDI IN connector.

Use knob [1] to select the MIDI page, use knob [2] to select "CLOCK," and use knob [3] to select "INTERNAL"; the **microKORG XL+** will be the master, and will transmit MIDI timing clock messages.

Set your external MIDI device to receive incoming MIDI clock messages. The external MIDI device (e.g., sequencer or rhythm machine) will operate at the tempo specified by the **microKORG XL+**'s [TEMPO] knob.

Using the external MIDI device as master and the microKORG XL+ as slave

Connect the **microKORG XL+**'s MIDI IN connector to your external MIDI device's MIDI OUT connector.

Use knob [1] to select the MIDI page, use knob [2] to select "CLOCK," and use knob [3] to select "EXT MIDI"; the **microKORG XL+** will be the slave.

Set your external MIDI device to transmit MIDI clock messages (as the master device). The **microKORG XL+**'s arpeggiator will operate at the tempo of the external device (e.g., sequencer or rhythm machine).

NOTE If you set the MIDI page "CLOCK" parameter to "AUTO," the **microKORG XL+** will automatically operate with the EXT MIDI setting whenever MIDI clock data is being received at the MIDI IN connector. At other times, the **microKORG XL+** will operate with the INTERNAL setting.

NOTE If the **microKORG XL+** receives a MIDI Start message [FA] when it is synchronized to the MIDI clock of an external MIDI device, the arpeggiator will be reset. Also, the phase of the LFO will be reset if "KEY SYNC" is OFF.

2. MIDI messages

MIDI channels

MIDI uses sixteen channels (1–16). MIDI messages can be transmitted and received when the channel of the receiving device matches the channel of the transmitting device.

This setting will affect the way in which channels are handled.

- If "VOIC.MODE" is SINGLE, LAYER, or SPLIT
If the COMMON page "VOIC.MODE" setting is SINGLE, LAYER, or SPLIT, MIDI data is transmitted/received on the global MIDI channel.
- If "VOIC.MODE" is Multi
If the COMMON page "VOIC.MODE" setting is MULTI, MIDI data for timbre 1 is transmitted/received on the global MIDI channel. MIDI data for timbre 2 is transmitted/received on the MIDI channel specified by the COMMON page "T2MIDI.CH" setting. Other transmission/reception uses the global MIDI channel.

NOTE The global MIDI channel is the basic MIDI channel used by the **microKORG XL+** to transmit and receive MIDI data. It is specified by the MIDI page setting "MIDI CH".

Note-on/off

Note-on [9n, kk, vv], Note-off [8n, kk, vv]

(n: channel, kk: note number, vv: velocity)

When you play the keyboard of the **microKORG XL+**, note-on/off messages are transmitted. The note-off velocity is transmitted at a fixed 64, but is not received.

If the GLOBAL page "POSITION" is POST KBD, note-on/off messages will be transmitted by the arpeggiator when it is running.

Program change, Bank select

Program change [Cn, pp]

(n: channel, pp: program number)

When you switch programs, a program change message with a program number for the corresponding program 1–128 (A11–B88) will be transmitted.

If you want program changes to be transmitted and received, set the MIDI FLT page “PROG CHG” to ENABLE. If this is set to DISABLE, program change messages will not be transmitted or received.

Bank select MSB (CC#00) [Bn, 00, mm]

Bank select LSB (CC#32) [Bn, 20, bb]

(n: channel, mm: bank number upper bytes, bb: bank number lower bytes)

When you switch programs in Play mode, Bank Select and Program Change messages are transmitted.

Bank (CC#00) MSB	Bank (CC#32) LSB	Program Change value	Bank&Prog Number
00	00	000–127 (00–7F)	A11–B88

You can use Bank select and program change messages to switch the settings of an individual timbre used by a program to the settings of another timbre, one used by a different program. These messages are received on the MIDI channel of the timbre selected by TIMBRE SELECT.

Bank (CC#00) MSB	Bank (CC#32) LSB	Program Change value	Timbre Number
32	32	000–127 (00–7F)	A11–B88 Timbre 1
32	33	000–127 (00–7F)	A11–B88 Timbre 2

Pitch bend

Pitch bend change [En, bb, mm]

(n: channel, bb: lower digits of value, mm: upper digits of value)

When pitch bend change messages are received, a pitch bend will occur according to the PITCH page “P.BEND” value. Pitch bend can also be used in a Virtual Patch (PATCH1–PATCH6 page) for a synth program, as a modulation source for a vocoder program (VC FILT page), or as a control source for a effect parameters. In this case, the message will act as a modulation source where mm=64, bb=00 will be 0 (center value) for the range of –127 – +127. (This message is received on the timbre channel.)

When you move the [PITCH] wheel on the **microKORG XL+**, pitch bend change messages are transmitted on the Global MIDI channel.

If you want pitch bend changes to be transmitted and received, set the MIDI FLT page “P.BEND” to ENABLE. If this is set to DISABLE, pitch bend change messages will not be transmitted or received.

Control changes

Control changes [Bn, cc, vv]

(n: channel, cc: control change no., vv: value)

When you use knobs [1]–[3] to edit certain parameters, or when you operate certain buttons or the [MOD] wheel, the assigned control change will be transmitted. Conversely, when control change numbers corresponding to the knob [1]–[3] settings are received, the corresponding controller or parameter will be controlled.

If you want control changes to be transmitted and received, set the MIDI FLT page “CTRL CHG” to Enable. If this is set to Disable, control change messages will not be transmitted or received.

NOTE Use the CC MAP page to assign control change messages to parameters.

- **Modulation depth (CC#01) [Bn, 01, vv]**

When a modulation depth message is received, the LFO2 vibrato depth will change according to the value specified for PITCH “VIB INT.” If the value of the received message is the maximum value (127), vibrato will be applied over the full pitch range specified by “VIB INT.” If the value of the received message is 0, no vibrato will apply.

When you move the **microKORG XL+**’s [MOD] wheel, modulation depth messages are transmitted on the Global MIDI channel.

- **Volume (CC#07) [Bn, 07, vv]**

If you assign the control change Volume (CC#07) to “LEVEL” in the CC MAP page, incoming Volume messages will control the volume.

- **Panpot (CC#10) [Bn, 0A, vv]**

If you assign the control change Panpot (CC#10) to “PANPOT” in the CC MAP page, incoming Panpot messages will control the stereo position of the sound.

- **Expression (CC#11) [Bn, 0B, vv]**

When expression messages are received, the volume of a timbre will be controlled. The volume will be at maximum if the maximum value (127) is received, and at zero if the minimum value (0) is received.

- **Damper pedal (CC#64) [Bn, 40, vv]**

Incoming damper pedal messages will turn the timbre's damper effect (Hold) on/off (0: Off, 127: On).

- **Portamento (CC#65) [Bn, 41, vv]**

When portamento messages are received, the portamento effect of a timbre will be switched on/off. If the portamento time is set to 0, there will be no portamento effect. (0: off, 7F: on)

- **All note off (CC#123) [Bn, 7B, 00] (value is 00)**

When an All Note Off message is received, all currently-sounding notes of that channel will be turned off. Some sound may linger due to the envelope settings.

- **All sound off (CC#120) [Bn, 78, 00] (value is 00)**

When an All Sound Off message is received, all notes currently sounding on that channel will be silenced. While All Note Off allows the decay of a note to continue, the All Sound Off will silence the sound immediately. However, this message is intended for use in emergencies, and is not for use during a performance.

- **Reset all controllers (CC#121) [Bn, 79, 00] (value is 00)**

When a Reset All Controllers message is received, all controller values currently operating on that channel will be reset. Some parameters assigned using Virtual Patch will not be reset.

Using a control change as a virtual patch modulation source

By selecting CC#cc (cc=00–95, 102–119) as the "SOURCE" for MIDI1, MIDI2, or MIDI3 in the PATCH page, you can use control changes as a modulation source for a virtual patch, vocoder "FC.MOD.SRC," or effect parameter. The actual value of 0–127 will be used without change as the modulation source.

Assigning a control change to a knob or button

In the CC MAP page, you can assign the control changes CC#00–CC#95 and CC#102–CC#119 to principal parameters that correspond to panel knobs and buttons. When you operate an assigned knob or key, the corresponding control change will be transmitted. When that control change is received from an external device, the result will be the same as if that knob or key had been operated with the corresponding value. (→ p. 90 "4.Front panel knob/button control change assignments")

3. Parameters transmitted and received via NRPN

Front panel knobs and buttons other than the controls listed above are assigned NRPN (Non Registered Parameter No.). NRPN messages can be used freely by any musical instrument manufacturer or model.

NRPN editing is performed using the following procedure.

1. Use NRPN MSB (CC#99) [Bn, 63, mm] and NRPN LSB (CC#98) [Bn, 62, rr] (n: channel, mm, rr: parameter no. upper and lower bytes) to select the parameter.
2. Use data entry MSB (CC#6) [Bn, 06, mm] (n: channel, mm: parameter value) to specify the value.

NOTE On the **microKORG XL+**, only data entry MSB is used.

Controlling the arpeggiator

When arpeggiator settings are modified by the front panel buttons or knobs, the following NRPN messages are transmitted. When these NRPN messages are received, the corresponding arpeggiator settings will change accordingly. These messages are transmitted and received on the Global MIDI channel. For the correspondence between the values of the message and the values of the **microKORG XL+** parameter, refer to the table.

- ON/OFF: [Bn, 63, 00, Bn, 62, 02, Bn, 06, mm]
- LATCH: [Bn, 63, 00, Bn, 62, 04, Bn, 06, mm]
- TYPE: [Bn, 63, 00, Bn, 62, 07, Bn, 06, mm]
- GATE: [Bn, 63, 00, Bn, 62, 0A, Bn, 06, mm]
- SELECT: [Bn, 63, 00, Bn, 62, 0B, Bn, 06, mm]
(n: channel, mm: parameter value)

	MSB (Hex)	LSB (Hex)	Value (transmitted)	Value (received)
ON/OFF	00(00)	02(02)	0: OFF, 127: ON	0...63: OFF, 64...127: ON
LATCH	00(00)	04(04)	0: OFF, 127: ON	0...63: OFF, 64...127: ON
TYPE	00(00)	07(07)	0...21: Up, 22...42: Down, 43...63: Alt1, 64...85: Alt2, 86...106: Random, 107...127: Trigger	0...21: Up, 22...42: Down, 43...63: Alt1, 64...85: Alt2, 86...106: Random, 107...127: Trigger
GATE	00(00)	10(0A)	Refer to "GATE values"	Refer to "GATE values"
SELECT	00(00)	11(0B)	0..42: Timbre1, 43...85: Timbre2, 86...127: Timbre1+2	0..42: Timbre1, 43...85: Timbre2, 86...127: Timbre1+2

GATE values

Value (transmitted, received)	Gate Time [%]	Value (transmitted, received)	Gate Time [%]	Value (transmitted, received)	Gate Time [%]	Value (transmitted, received)	Gate Time [%]
0	000	33	026	66	052	99	078
1, 2	001	34	027	67	053	100	079
3	002	35, 36	028	68, 69	054	101, 102	080
4	003	37	029	70	055	103	081
5	004	38	030	71	056	104	082
6, 7	005	39, 40	031	72, 73	057	105	083
8	006	41	032	74	058	106, 107	084
9	007	42	033	75	059	108	085
10	008	43	034	76	060	109	086
11, 12	009	44, 45	035	77, 78	061	110, 111	087
13	010	46	036	79	062	112	088
14	011	47	037	80	063	113	089
15	012	48	038	81	064	114	90
16, 17	013	49, 50	039	82, 83	065	115, 116	91
18	014	51	040	84	066	117	92
19	015	52	041	85	067	118	93
20, 21	016	53	042	86	068	119	94
22	017	54, 55	043	87, 88	069	120, 121	95
23	018	56	044	89	070	122	96
24	019	57	045	90	071	123	97
25, 26	020	58, 59	046	91, 92	072	124	98
27	021	60	047	93	073	125, 126	99
28	022	61	048	94	074	127	100
29	023	62	049	95	075		
30, 31	024	63, 64	050	96, 97	076		
32	025	65	051	98	077		

For example if you want to switch the arpeggiator on/off from an external MIDI sequencer, make the following settings.

Off: CC#99: 0, CC#98: 2, CC#6: 0...63 On: CC#99: 0, CC#98: 2, CC#6: 64...127

Controlling the Timbre parameters

These messages are transmitted and received on the Global MIDI channel.

Controlling the Virtual Patch1...Patch6 Source

- Source1...Source6: [Bn, 63, 04, Bn, 62, 00...05, Bn, 06, mm]
(n: channel, mm: parameter value)

	MSB (Hex)	LSB (Hex)	Value (transmitted)	Value (received)
Patch1 Source	04(04)	00(00)	0...10: EG1, 11...20: EG2,	0...10: EG1, 11...20: EG2,
Patch2 Source	04(04)	01(01)	21...31: EG3, 32...42: LFO1,	21...31: EG3, 32...42: LFO1,
Patch3 Source	04(04)	02(02)	43...52: LFO2, 53...63: Velocity,	43...52: LFO2, 53...63: Velocity,
Patch4 Source	04(04)	03(03)	64...74: Pitch Bend, 75...84: Mod Wheel,	64...74: Pitch Bend, 75...84: Mod Wheel,
Patch5 Source	04(04)	04(04)	85...95: Keyboard Track, 96...106: MIDI1,	85...95: Keyboard Track, 96...106: MIDI1,
Patch6 Source	04(04)	05(05)	107...116: MIDI2, 117...127: MIDI3	107...116: MIDI2, 117...127: MIDI3

Controlling the Virtual Patch1...Patch6 Destination

- Dest1...Dest6: [Bn, 63, 04, Bn, 62, 08...0D, Bn, 06, mm]
(n: channel, mm: parameter value)

	MSB (Hex)	LSB (Hex)	Value (transmitted)	Value (received)
Patch1 Dest	04(04)	08(08)	0...2: Pitch, 3...5: OSC2 Tune, 6...9: OSC1 Control 1, 10...12: OSC1 Level, 13...15: OSC2 Level, 16...18: NOISE Level, 19...21: Filter1 Type Balance, 22...25: Filter1 Cutoff, 26...28: Filter1 Resonance, 29...31: Filter2 Cutoff, 32...34: Drive/WS Depth, 35...37: AMP Level, 38...41: Panpot, 42...44: LFO1 Frequency, 45...47: LFO2 Frequency, 48...50: Portamento, 51...53: OSC1 Control 2, 54...57: Filter1 EG1 Int, 58...60: Filter1 Key Track, 61...63: Filter2 Resonance, 64...66: Filter2 EG1 Int, 67...69: Filter2 Key Track, 70...73: EG1 Attack, 74...76: EG1 Decay, 77...79: EG1 Sustain, 80...82: EG1 Release, 83...85: EG2 Attack, 86...89: EG2 Decay, 90...92: EG2 Sustain, 93...95: EG2 Release, 96...98: EG3 Attack, 99...101: EG3 Decay, 102...105: EG3 Sustain, 106...108: EG3 Release, 109...111: Patch1 Int, 112...114: Patch2 Int, 115...117: Patch3 Int, 118...121: Patch4 Int, 122...124: Patch5 Int, 125...127: Patch6 Int	0...2: Pitch, 3...5: OSC2 Tune, 6...9: OSC1 Control 1, 10...12: OSC1 Level, 13...15: OSC2 Level, 16...18: NOISE Level, 19...21: Filter1 Type Balance, 22...25: Filter1 Cutoff, 26...28: Filter1 Resonance, 29...31: Filter2 Cutoff, 32...34: Drive/WS Depth, 35...37: AMP Level, 38...41: Panpot, 42...44: LFO1 Frequency, 45...47: LFO2 Frequency, 48...50: Portamento, 51...53: OSC1 Control 2, 54...57: Filter1 EG1 Int, 58...60: Filter1 Key Track, 61...63: Filter2 Resonance, 64...66: Filter2 EG1 Int, 67...69: Filter2 Key Track, 70...73: EG1 Attack, 74...76: EG1 Decay, 77...79: EG1 Sustain, 80...82: EG1 Release, 83...85: EG2 Attack, 86...89: EG2 Decay, 90...92: EG2 Sustain, 93...95: EG2 Release, 96...98: EG3 Attack, 99...101: EG3 Decay, 102...105: EG3 Sustain, 106...108: EG3 Release, 109...111: Patch1 Int, 112...114: Patch2 Int, 115...117: Patch3 Int, 118...121: Patch4 Int, 122...124: Patch5 Int, 125...127: Patch6 Int
Patch2 Dest	04(04)	09(09)		
Patch3 Dest	04(04)	10(0A)		
Patch4 Dest	04(04)	11(0B)		
Patch5 Dest	04(04)	12(0C)		
Patch6 Dest	04(04)	13(0D)		

Controlling the vocoder parameters

These messages are transmitted and received on the Global MIDI channel.

Fc Modulation Source

FC.MOD.SRC (Fc Modulation Source): [Bn, 63, 04, Bn, 62, 00, Bn, 06, mm]

(n: channel, mm: parameter value)

Fc Mod Sorce	Value (transmitted)	Value (received)
EG1	0...10	0...10
EG2	11...20	11...20
EG3	21...31	21...31
LFO1	32...42	32...42
LFO2	43...52	43...52
Velocity	53...63	53...63
Pitch Bend	64...74	64...74
Mod Wheel	75...84	75...84
Keyboard Track	85...95	85...95
MIDI1	96...106	96...106
MIDI2	107...116	107...116
MIDI3	117...127	117...127

Band parameters

You can control the output level and pan for each band of the vocoder's synthesis filter.

Level1...Level16: [Bn, 63, 04, Bn, 62, 40...4F, Bn, 06, mm]

(n: channel, mm: parameter value)

Pan1...Pan16: [Bn, 63, 04, Bn, 62, 50...5F, Bn, 06, mm]

(n: channel, mm: parameter value)



If you want to transmit and receive these parameters between two **microKORG XL+** units, make the same program settings on both the transmitting and receiving units.

Vocoder Switch

Vocoder switch: [*Bn*, 63, 05, *Bn*, 62, 04, *Bn*, 06, *mm*]

(*n*: channel, *mm*: parameter value)

	MSB (Hex)	LSB (Hex)	Value (transmitted)	Value (received)
Vocoder Sw	05(05)	04(00)	0...63: OFF, 64...127: ON	0...63: OFF, 64...127: ON

Other controls

These messages are transmitted and received on the Global MIDI channel.

Voice Mode (COMMON page "VOIC.MODE")

Voice Mode ("VOIC.MODE"): [*Bn*, 63, 05, *Bn*, 62, 00, *Bn*, 06, *mm*]

(*n*: channel, *mm*: parameter value)

	MSB (Hex)	LSB (Hex)	Value (transmitted)	Value (received)
Voice Mode	05(05)	00(00)	0...31: SINGLE, 32...63: LAYER, 64...95: SPLIT, 96...127: MULTI	0...31: SINGLE, 32...63: LAYER, 64...95: SPLIT, 96...127: MULTI

System exclusive messages

microKORG XL+ format

F0: exclusive status

42: Korg ID

3n: [*n*=0–F] MIDI channel

00, 01, 19: *microKORG XL+* model ID

ff: function ID (type of message)

—

F7: end of exclusive

Universal system exclusive

System exclusive messages include a special category of messages whose purpose is officially defined. These are called universal system exclusive messages. Of these universal system exclusive messages, the *microKORG XL+* supports Master Volume and Master Fine Tuning.

Master volume [*F0*, 7*F*, *nn*, 04, 01, *vv*, *mm*, *F7*]

(*vv*: lower byte of value, *mm*: upper byte of value, [*mm*, *vv*=7*F*, 7*F*] is Max, [*mm*, *vv*=00, 00] is 0)

When a Master Volume message is received, the *microKORG XL+* will adjust its overall volume.

Master fine tuning [*F0*, 7*F*, *nn*, 04, 03, *vv*, *mm*, *F7*]

(A value of 8192 [*mm*, *vv*=40, 00] is center (0 cent, A4=440.0Hz), 4096 [*mm*, *vv*=20, 00] is -50 cents, and 12288 [*mm*, *vv*=60, 00] is +50 cents.)

When master fine tuning is received, the value specified for the *microKORG XL+*'s GLOBAL page "MST TUNE" will be ignored, and the overall pitch will be specified by the data that was received.

Realtime Messages

Starting/stopping the arpeggiator

When the *microKORG XL+*'s arpeggiator is synchronized to a connected external MIDI device, system realtime messages Start and Stop will control the arpeggiator.

Start [*FA*]

When the Start [*FA*] message is received, the arpeggio pattern will be reset to its beginning.

Stop [*FC*]

When a Stop [*FC*] message is received, the arpeggiator will stop. (It will not be turned off; the arpeggiator will start again when additional notes are played.)

4. Front panel knob/button control change assignments

Control changes can be assigned to each front panel knob/button of the **microKORG XL+** so that the changes in sound as controlled by knob/button operations can be transmitted as performance data.

NOTE For details on assigning control changes to the **microKORG XL+**'s knobs and buttons, refer to page 61 "CC MAP (MIDI Control Change No. Map)".

NOTE Different parameters are assigned to synth parameters and vocoder parameters.



If you are using two **microKORG XL+** units to transmit and receive these parameters, you must set the transmitting and receiving programs to the same settings.

Page	Parameter	Initial	Value (transmitted)	Value (received)
UNISON	MODE	CC#03	0...31: OFF, 32...63: 2VOICE, 64...95: 3VOICE, 96...127: 4VOICE	0...31: OFF, 32...63: 2VOICE, 64...95: 3VOICE, 96...127: 4VOICE
PITCH	PORTMNT0	CC#05	0...127	0...127
OSC1	WAVE	CC#08	0...15: SAW, 16...31: PULSE, 32...47: TRIANGLE, 48...63: SINE, 64...79: FORMANT, 80...95: NOISE, 96...111: PCM/DWGS, 112...127: AUDIO IN	0...15: SAW, 16...31: PULSE, 32...47: TRIANGLE, 48...63: SINE, 64...79: FORMANT, 80...95: NOISE, 96...111: PCM/DWGS, 112...127: AUDIO IN
	OSC MOD	CC#09	0...31: WAVEFORM, 32...63: CROSS, 64...95: UNISON, 96...127: VPM	0...31: WAVEFORM, 32...63: CROSS, 64...95: UNISON, 96...127: VPM
	OSC1.C1	CC#15	0...127	0...127
	OSC1.C2	CC#17	0...127	0...127 (OSC MOD=VPM: 1...32:0...127)
OSC2	WAVE	CC#18	0...31: SAW, 32...63: PULSE, 64...95: TRIANGLE, 96...127: SINE	0...31: SAW, 32...63: PULSE, 64...95: TRIANGLE, 96...127: SINE
	OSC MOD	CC#19	0...31: OFF, 32...63: RING, 64...95: SYNC, 96...127: RING.SYNC	0...31: OFF, 32...63: RING, 64...95: SYNC, 96...127: RING.SYNC
	SEMITONE	CC#20	→ p. 41 "SEMITONE (Oscillator 2 Semitone)"	→ p. 41 "SEMITONE (Oscillator 2 Semitone)"
	TUNE	CC#21	0...127	0...127
MIXER	OSC1 LVL	CC#23	0...127	0...127
	OSC2 LVL	CC#24	0...127	0...127
	NOISE.LVL	CC#25	0...127	0...127
FILTER1	CUTOFF	CC#74	0...127	0...127
	RESO	CC#71	0...127	0...127
	TYPE BAL	CC#27	→ p. 92 ""TYPE BAL" values"	→ p. 92 ""TYPE BAL" values"
	ROUTING1	CC#26	0...31: SINGLE, 32...63: SERIAL, 64...95: PARALLEL, 96...127: INDIV	0...31: SINGLE, 32...63: SERIAL, 64...95: PARALLEL, 96...127: INDIV
	EG1 INT	CC#79	0/1: -63, 2: -62...63: -1, 64: 0, 65: +1...127: +63	0/1: -63, 2: -62...63: -1, 64: 0, 65: +1...127: +63
	KEY TRK	CC#28	0/1: -2... 64: 0...127: +2	0/1: -2... 64: 0...127: +2

FILTER2	CUTOFF	CC#30	0...127	0...127
	RESO	CC#68	0...127	0...127
	TYPE	CC#29	0...42: LPF, 43...83: HPF, 85...127: BPF	0...42: LPF, 43...83: HPF, 85...127: BPF
	EG1 INT	CC#69	0/1: -63, 2: -62...63: -1, 64: 0, 65: +1...127: +63	0/1: -63, 2: -62...63: -1, 64: 0, 65: +1...127: +63
AMP	KEY TRK	CC#82	0/1: -2... 64: 0...127: +2	0/1: -2... 64: 0...127: +2
	LEVEL	CC#07	0...127	0...127
DRIVE/WS	PANPOT	CC#10	0/1: L63, 2: L62...63: L01, 64: CNT, 65: R01...127: R63	0/1: L63, 2: L62...63: L01, 64: CNT, 65: R01...127: R63
	WS DEPTH	CC#83	0...127	0...127
EG1	ATTACK	CC#85	0...127	0...127
	DECAY	CC#86	0...127	0...127
	SUSTAIN	CC#87	0...127	0...127
	RELEASE	CC#88	0...127	0...127
EG2	ATTACK	CC#73	0...127	0...127
	DECAY	CC#75	0...127	0...127
	SUSTAIN	CC#70	0...127	0...127
	RELEASE	CC#72	0...127	0...127
LFO1	WAVE	CC#89	0...25: SAW, 26...50: SQUARE, 51...76: TRIANGLE, 77...101: S/H, 102...127: RANDOM	0...25: SAW, 26...50: SQUARE, 51...76: TRIANGLE, 77...101: S/H, 102...127: RANDOM
	FREQ	CC#90	0...127, BPM SYNC=ON: → p. 93	0...127, BPM SYNC=ON: → p. 93
LFO2	WAVE	CC#102	0...25: SAW, 26...50: SQUARE, 51...76: SINE, 77...101: S&H, 102...127: RANDOM	0...25: SAW, 26...50: SQUARE, 51...76: SINE, 77...101: S&H, 102...127: RANDOM
	FREQ	CC#76	0...127, BPM SYNC=ON: → p. 93	0...127, BPM SYNC=ON: → p. 93
PATCH1	INTENSTY	CC#103	0/1: -63, 2: -62...63: -1, 64: 0, 65: +1...127: +63	0/1: -63, 2: -62...63: -1, 64: 0, 65: +1...127: +63
PATCH2	INTENSTY	CC#104	0/1: -63, 2: -62...63: -1, 64: 0, 65: +1...127: +63	0/1: -63, 2: -62...63: -1, 64: 0, 65: +1...127: +63
PATCH3	INTENSTY	CC#105	0/1: -63, 2: -62...63: -1, 64: 0, 65: +1...127: +63	0/1: -63, 2: -62...63: -1, 64: 0, 65: +1...127: +63
PATCH4	INTENSTY	CC#106	0/1: -63, 2: -62...63: -1, 64: 0, 65: +1...127: +63	0/1: -63, 2: -62...63: -1, 64: 0, 65: +1...127: +63
PATCH5	INTENSTY	CC#107	0/1: -63, 2: -62...63: -1, 64: 0, 65: +1...127: +63	0/1: -63, 2: -62...63: -1, 64: 0, 65: +1...127: +63
PATCH6	INTENSTY	CC#108	0/1: -63, 2: -62...63: -1, 64: 0, 65: +1...127: +63	0/1: -63, 2: -62...63: -1, 64: 0, 65: +1...127: +63
EQ	LO GAIN	CC#110	→ p. 93 ""EQ Gain" values"	→ p. 93 ""EQ Gain" values"
	HI GAIN	CC#109	→ p. 93 ""EQ Gain" values"	→ p. 93 ""EQ Gain" values"
MST FX1	DRY/WET	CC#115	0...127	0: Dry, 1...126, 127: Wet
	CTRL-1	CC#12	0...127	0...127
	CTRL-2	CC#112	0...127	0...127
MST FX2	DRY/WET	CC#116	0...127	0: Dry, 1...126, 127: Wet
	CTRL-1	CC#13	0...127	0...127
	CTRL-2	CC#113	0...127	0...127
VC MOD	THRESHLD	off	0...127	0...127
	HPF LVL	off	0...127	0...127
	HPF GATE	off	0: DISABLE, 127:ENABLE	0...63: DISABLE, 64...127: ENABLE
VC CARRI	TMBR1.LVL	off	0...127	0...127
	TMBR2.LVL	off	0...127	0...127

VC FILT	FRMNT.SFT	off	0...25: -2, 26...51: -1, 52...76: 0, 77...102: +1, 103...127: +2	0...25: -2, 26...51: -1, 52...76: 0, 77...102: +1, 103...127: +2
	FC.OFFSET	off	0/1: -63, 2: -62...63: -1, 64: 0, 65: +1...127: +63	0/1: -63, 2: -62...63: -1, 64: 0, 65: +1...127: +63
	RESO	off	0...127	0...127
	FC.MOD.INT	off	0/1: -63, 2: -62...63: -1, 64: 0, 65: +1...127: +63	0/1: -63, 2: -62...63: -1, 64: 0, 65: +1...127: +63
	EF SENS	off	0...126, 127: HOLD	0...126, 127: HOLD
VC AMP	VC LEVEL	off	0...127	0...127
	DIRCT.LVL	off	0...127	0...127

OSC 2 “SEMITONE” values

The following table shows how the control change values transmitted/received by the OSC2 page “SEMITONE” setting correspond to the value of the parameter.

Value (transmitted, received)	SEMITONE	Value (transmitted, received)	SEMITONE
0...2	-24	66, 67	+1
3...5	-23	68...70	+2
6, 7	-22	71...73	+3
8...10	-21	74, 75	+4
11...13	-20	76...78	+5
14, 15	-19	79, 80	+6
16...18	-18	81...83	+7
19, 20	-17	84...86	+8
21...23	-16	87, 88	+9
24...26	-15	89...91	+10
27, 28	-14	92...94	+11
29...31	-13	95, 96	+12
32, 33	-12	97...99	+13
34...36	-11	100, 101	+14
37...39	-10	102...104	+15
40, 41	-9	105...107	+16
42...44	-8	108, 109	+17
45...47	-7	110...112	+18
48, 49	-6	113, 114	+19
50...52	-5	115...117	+20
53, 54	-4	118...120	+21
55...57	-3	121, 122	+22
58...60	-2	123...125	+23
61, 62	-1	126, 127	+24
63...65	0		

“TYPE BAL” values

The following table shows how the control change values transmitted/received by the FILT1 page “TYPE BAL” setting correspond to the value of the parameter.

Value (transmitted, received)	TYPE BAL
0	-24LPF
1...30	Intermediate the characters between -24LPF and -12LPF.
31...33	-12LPF
34...62	Intermediate the characters between -12LPF and HPF.
63...65	HPF
66...94	Intermediate the characters between HPF and BPF.
95...97	BPF
98...126	Intermediate the characters between BPF and THRU.
127	THRU

“SYNC.NOTE” value when LFO 1/2 or DELAY “BPM SYNC” = ON

If BPM SYNC is on, the “FREQ” parameter of LFO 1/2 and the delay parameter of the master effects will change to “SYNC.NOTE.” In conjunction with this, the correspondence between the parameter value and the control change value transmitted/received when you operate a knob will change as follows.

Value (transmitted, received)	LFO Sync Note	DELAY Sync Note
0...7	8/1	8/1
8...14	4/1	4/1
15...22	2/1	2/1
23...29	1/1	1/1
30...37	3/4	3/4
38...44	1/2	1/2
45...52	3/8	3/8
53...59	1/3	1/3
60...67	1/4	1/4
68...74	3/16	3/16
75...82	1/6	1/6
83...89	1/8	1/8
90...97	1/12	1/12
98...104	1/16	1/16
105...112	1/24	1/24
113...119	1/32	1/32
120...127	1/64	1/64

“EQ Gain” values

The following table shows the correspondence between the parameter value and control change value transmitted/received when you adjust the EQ page “GAIN” parameter.

Value (transmitted, received)	EQ Gain (dB)	Value (transmitted, received)	EQ Gain (dB)
0...2	-15.0	66, 67	+0.5
3, 4	-14.5	68, 69	+1.0
5, 6	-14.0	70, 71	+1.5
7, 8	-13.5	72, 73	+2.0
9, 10	-13.0	74, 75	+2.5
11, 12	-12.5	76, 77	+3.0
13, 14	-12.0	78, 79	+3.5
15, 16	-11.5	80, 81	+4.0
17, 18	-11.0	82, 83	+4.5
19, 20	-10.5	84...86	+5.0
21...23	-10.0	87, 88	+5.5
24, 25	-9.5	89, 90	+6.0
26, 27	-9.0	91, 92	+6.5
28, 29	-8.5	93, 94	+7.0
30, 31	-8.0	95, 96	+7.5
32, 33	-7.5	97, 98	+8.0
34, 35	-7.0	99, 100	+8.5
36, 37	-6.5	101, 102	+9.0
38, 39	-6.0	103, 104	+9.5
40, 41	-5.5	105...107	+10.0
42...44	-5.0	108, 109	+10.5
45, 46	-4.5	110, 111	+11.0
47, 48	-4.0	112, 113	+11.5
49, 50	-3.5	114, 115	+12.0
51, 52	-3.0	116, 117	+12.5
53, 54	-2.5	118, 119	+13.0
55, 56	-2.0	120, 121	+13.5
57, 58	-1.5	122, 123	+14.0
59, 60	-1.0	124, 125	+14.5
61, 62	-0.5	126 127	+15.0
63...65	+0.0		

Appendices

1. Trouble shooting

Before you suspect a malfunction, please check the following points.

Power does not turn on

- Is the AC adapter connected to an AC outlet? → p. 9

No sound

- Is your powered monitor system or headphones connected to the correct jack(s)? → p. 9
- Is the connected monitor system powered-on, and is the volume raised?
- Is the VOLUME knob set to a position where sound will be output?
- Is the MIDI page “LOCAL” setting turned ON? → p. 59
- Were any volume-related parameters set to a value of 0?
- Could “CUTOFF” be set to 0 in the FILTER page or another page? → p. 42
- Could the VC FILT page “EF.SENS” parameter be set to HOLD (FORMANT HOLD) when there is no input to the AUDIO IN [LINE] jack or [MIC] jack?

Can't input sound

- Is the input source connected to the AUDIO IN [LINE] jack or [MIC] jack?
- If you're using the AUDIO IN [MIC] jack, is the [XLR/LINE] switch set to XLR?
- If you're using the AUDIO IN [LINE] jack, is the [XLR/LINE] switch set to LINE?
- Is the AUDIO IN [VOLUME] knob level raised?
- For a vocoder program, is the audio source you're using as the modulator connected to the AUDIO IN [LINE] jack? Alternatively, have you connected a mic to the AUDIO IN [MIC] jack?

Can't edit

- Can't use performance editing by turning knobs [1]–[3]:
Could you be in Full Edit mode?
- Turning the knobs [1]–[3] does not modify the edit parameters:
Could the GLOBAL page “KNOB.MODE” be set to “CATCH”? → p. 24
- Turning the knobs [1]–[3] does not affect the sound:
Have you used the TIMBRE SELECT lever to select the timbre you want to edit?
- Can't select timbre 2:
Have you set the COMMON page “VOIC.MODE” parameter to something other than SINGLE?
- Can't select vocoder parameters in Full Edit mode:
Is the [VOCODER] button selected?
- If the changes you made to a program or to the global settings have not been remembered, did you turn the power off before executing the Write operation? In the case of a program, your edits will also be lost if you select a different program. Execute the Write operation to save your edits before you switch programs or turn off the power. → p. 31

Can't write programs or global settings

- Is the GLOBAL page PROTECT setting OFF?
- If the edited program or global setting did not remain, did you use knob [1] to specify the data to be saved when you executed the Write operation?

Arpeggiator will not start

- Is the arpeggiator on ([ARP ON] key lit)?
- Is the arpeggiator assigned to a timbre?
- Is the MIDI page "CLOCK" setting correct?

No response to MIDI messages sent from an external device

- Is the MIDI cable or USB cable connected correctly?
- Does the MIDI channel of the data transmitted from the external MIDI device match the MIDI channel of the **microKORG XL+**.

Does not respond correctly to MIDI messages sent from an external device

- Is the MIDI FLT page parameter for that type of MIDI message set to Enable?

Transpose, velocity curve, and arpeggiator data is not recognized correctly

- Is the GLOBAL page "POSITION" set appropriately?

Can't control two timbres on separate MIDI channels

- The **microKORG XL+** uses only one MIDI channel to transmit and receive when the COMMON page "VOIC.MODE" is set to SINGLE, LAYER, or SPLIT. You can use two MIDI channels to play the two timbres independently only when COMMON page "VOIC.MODE" is set to MULTI.

2. Program List

No.	Program Name	Genre	Category	Arpeggio
A11	ANALOG	70'S VINTAGE	POLY SYNTH	Off
A12	MG BASS	70'S VINTAGE	BASS	Off
A13	WAKELEAD	70'S VINTAGE	LEAD	Off
A14	TIMELINE	70'S VINTAGE	ARP/MOTION	On
A15	TAPE STR	70'S VINTAGE	PAD/STRINGS	Off
A16	TAPE FLT	70'S VINTAGE	KEYBOARD/BELL	Off
A17	KROSS FX	70'S VINTAGE	S.E./HIT	Off
A18	VOC PULS	70'S VINTAGE	VOCODER/AUDIO IN	Off
A21	OB JUMPR	ROCK	POLY SYNTH	Off
A22	BAKIN'BS	ROCK	BASS	Off
A23	ROBOSYNC	ROCK	LEAD	Off
A24	VPM ARP	ROCK	ARP/MOTION	On
A25	PWM STR	ROCK	PAD/STRINGS	Off
A26	VOX ORG	ROCK	KEYBOARD/BELL	Off
A27	SYN DRUM	ROCK	S.E./HIT	Off
A28	VOC ENS	ROCK	VOCODER/AUDIO IN	Off
A31	SYNBASS	POP	POLY SYNTH	Off
A32	VELOSLAP	POP	BASS	Off
A33	FUSIONLD	POP	LEAD	Off
A34	MINDTRIP	POP	ARP/MOTION	On
A35	WHOO PAD	POP	PAD/STRINGS	Off
A36	SG PIANO	POP	KEYBOARD/BELL	Off
A37	8BIT GAL	POP	S.E./HIT	Off
A38	A FEMALE	POP	VOCODER/AUDIO IN	Off
A41	DAYNITE	HIPHOP	POLY SYNTH	Off
A42	JAMI BS	HIPHOP	BASS	Off
A43	WHEEL LD	HIPHOP	LEAD	Off
A44	BTRFLYFX	HIPHOP	ARP/MOTION	Off
A45	WARM PAD	HIPHOP	PAD/STRINGS	Off
A46	PHASE EP	HIPHOP	KEYBOARD/BELL	Off
A47	DOMIN8OR	HIPHOP	S.E./HIT	Off
A48	GALAKTIC	HIPHOP	VOCODER/AUDIO IN	Off

No.	Program Name	Genre	Category	Arpeggio
A51	SLIP PAD	DANCE	POLY SYNTH	Off
A52	SATISFAC	DANCE	BASS	Off
A53	8VESAW	DANCE	LEAD	Off
A54	BUILDER	DANCE	ARP/MOTION	Off
A55	EVOLTION	DANCE	PAD/STRINGS	Off
A56	M1 ORGAN	DANCE	KEYBOARD/BELL	Off
A57	CHORDHIT	DANCE	S.E./HIT	Off
A58	ROBOTVOC	DANCE	VOCODER/AUDIO IN	Off
A61	FILLER	DUBSTEP	POLY SYNTH	Off
A62	EVILSTEP	DUBSTEP	BASS	Off
A63	SCARY LD	DUBSTEP	LEAD	Off
A64	MODSWEEP	DUBSTEP	ARP/MOTION	Off
A65	BPF PLUS	DUBSTEP	PAD/STRINGS	Off
A66	RADIATE	DUBSTEP	KEYBOARD/BELL	Off
A67	GROWLFX	DUBSTEP	S.E./HIT	Off
A68	DEVILVOX	DUBSTEP	VOCODER/AUDIO IN	Off
A71	DUO SIGN	ELECTRONICA	POLY SYNTH	Off
A72	MS-101	ELECTRONICA	BASS	Off
A73	PHUNKYLD	ELECTRONICA	LEAD	Off
A74	TRIPCYCL	ELECTRONICA	ARP/MOTION	Off
A75	LAGOON	ELECTRONICA	PAD/STRINGS	Off
A76	ICEFIELD	ELECTRONICA	KEYBOARD/BELL	Off
A77	P6 CHORD	ELECTRONICA	S.E./HIT	Off
A78	SPECTMOD	ELECTRONICA	VOCODER/AUDIO IN	Off
A81	LOFI SYN	FAVORITE	POLY SYNTH	Off
A82	DIRTY	FAVORITE	BASS	Off
A83	UNISONSQ	FAVORITE	LEAD	Off
A84	RHYZMICA	FAVORITE	ARP/MOTION	On
A85	MELTYPAD	FAVORITE	PAD/STRINGS	Off
A86	SYN CLAV	FAVORITE	KEYBOARD/BELL	Off
A87	JUNGLE	FAVORITE	S.E./HIT	On
A88	V-CHANGE	FAVORITE	VOCODER/AUDIO IN	Off
B11	POLYLINE	70'S VINTAGE	POLY SYNTH	Off
B12	ODDSY BS	70'S VINTAGE	BASS	Off
B13	ARPELEON	70'S VINTAGE	LEAD	Off

No.	Program Name	Genre	Category	Arpeggio
B14	Z-FIELD	70'S VINTAGE	ARP/MOTION	On
B15	SOLINSTR	70'S VINTAGE	PAD/STRINGS	Off
B16	WURLY EP	70'S VINTAGE	KEYBOARD/BELL	Off
B17	INSPACE	70'S VINTAGE	S.E./HIT	Off
B18	VOC 5TH	70'S VINTAGE	VOCODER/AUDIO IN	Off
B21	SEP WAVE	ROCK	POLY SYNTH	Off
B22	SMACK IT	ROCK	BASS	Off
B23	MG 5THLD	ROCK	LEAD	Off
B24	AMBDRIIVE	ROCK	ARP/MOTION	Off
B25	MOTHER	ROCK	PAD/STRINGS	Off
B26	C-PIANO	ROCK	KEYBOARD/BELL	Off
B27	SIREN	ROCK	S.E./HIT	Off
B28	AIRY VOC	ROCK	VOCODER/AUDIO IN	Off
B31	BRASSENS	POP	POLY SYNTH	Off
B32	VPM BASS	POP	BASS	Off
B33	POCKETLD	POP	LEAD	Off
B34	S&H PAD	POP	ARP/MOTION	Off
B35	AIRGLASS	POP	PAD/STRINGS	Off
B36	DYNO EP	POP	KEYBOARD/BELL	Off
B37	ORGCHORD	POP	S.E./HIT	Off
B38	A MALE	POP	VOCODER/AUDIO IN	Off
B41	TIKTOK	HIPHOP	POLY SYNTH	Off
B42	BUT BASS	HIPHOP	BASS	Off
B43	FUN LEAD	HIPHOP	LEAD	Off
B44	TLKVOXER	HIPHOP	ARP/MOTION	On
B45	LOW PAD	HIPHOP	PAD/STRINGS	Off
B46	PLAYTHAT	HIPHOP	KEYBOARD/BELL	Off
B47	FROM2036	HIPHOP	S.E./HIT	Off
B48	WISPAVOC	HIPHOP	VOCODER/AUDIO IN	Off
B51	TRANCER	DANCE	POLY SYNTH	Off
B52	DEE I EM	DANCE	BASS	Off
B53	SCREAMLD	DANCE	LEAD	Off
B54	DIGIPUMP	DANCE	ARP/MOTION	On
B55	FLASHPAD	DANCE	PAD/STRINGS	Off
B56	ORGAN	DANCE	KEYBOARD/BELL	Off

No.	Program Name	Genre	Category	Arpeggio
B57	2MANYOSC	DANCE	S.E./HIT	Off
B58	VOC FLNG	DANCE	VOCODER/AUDIO IN	Off
B61	SCREAMER	DUBSTEP	POLY SYNTH	Off
B62	TECHSTEP	DUBSTEP	BASS	Off
B63	SCIENCE	DUBSTEP	LEAD	Off
B64	X-STEP	DUBSTEP	ARP/MOTION	On
B65	BELLY	DUBSTEP	PAD/STRINGS	Off
B66	TUBULAR	DUBSTEP	KEYBOARD/BELL	Off
B67	BITBUG	DUBSTEP	S.E./HIT	Off
B68	VOC WAH	DUBSTEP	VOCODER/AUDIO IN	Off
B71	IDM5100	ELECTRONICA	POLY SYNTH	Off
B72	REV BASS	ELECTRONICA	BASS	Off
B73	EDGE LD	ELECTRONICA	LEAD	Off
B74	FLAPPER	ELECTRONICA	ARP/MOTION	On
B75	SWEEP PAD	ELECTRONICA	PAD/STRINGS	Off
B76	DEEPBELL	ELECTRONICA	KEYBOARD/BELL	Off
B77	ESKAYTWO	ELECTRONICA	S.E./HIT	On
B78	VOC DWGS	ELECTRONICA	VOCODER/AUDIO IN	Off
B81	SQ COMP	FAVORITE	POLY SYNTH	Off
B82	KAMELEON	FAVORITE	BASS	Off
B83	DA LEAD	FAVORITE	LEAD	Off
B84	PHAZKIT	FAVORITE	ARP/MOTION	On
B85	HIGH STR	FAVORITE	PAD/STRINGS	Off
B86	VPM EP	FAVORITE	KEYBOARD/BELL	Off
B87	BOMBDROP	FAVORITE	S.E./HIT	Off
B88	AUDIO IN	FAVORITE	VOCODER/AUDIO IN	Off

NOTE The sounds A18, A28, A48, A58, A68, A78, A88, B18, B28, B48, B58, B68, B78, and B88 are programs that use the mic input (audio input). In order to play these sounds, you must connect a mic or external audio device to the **microKORG XL+** and play the keyboard while sound is being input.

NOTE With the factory settings, the Timbre 2 MIDI channel is set to "9" for programs whose Voice Mode is set to Multi.

3. Demo Song

No.	Song Name	Author
1	PREVIEW1	KORG Inc.
2	PREVIEW2	Katsuyuki Mito
3	PREVIEW3	Katsuyuki Mito
4	TRIPCYCL	KORG Inc.
5	CLUBSTAR	Henning Verlage
6	SNOW	KORG Inc.
7	RADIOTEK	KORG Inc.
8	TLKBOXER	KORG Inc.
9	EVOLTION	Henning Verlage
10	PREVIEW4	H.V. x KORG Inc.

All Demo Songs: ©2012 KORG Inc. —All rights reserved.

For more information about the authors please visit :

Katsuyuki Mito (<http://mito310.seesaa.net/>)

Henning Verlage(www.facebook.com/henningverlage)

4. Specifications

Sound generation system

MMT (Multiple Modeling Technology)

Programs

Number of timbres Maximum 2 (when using Layer, Split, or Multi)
Polyphony 8 voices (up to 4 when the vocoder is selected)

Synth 2 oscillator + noise generator

Oscillator 1

Waveform SAW, PULSE, TRIANGLE, SINE, FORMANT, NOISE, PCM/DWGS, AUDIO IN

Modulation WAVEFORM, CROSS, UNISON, VPM

Oscillator 2

Waveform SAW, PULSE, TRIANGLE, SINE

Modulation RING, SYNC, RING+SYNC

Wave shaping

WS type DRIVE, DECIMATOR, HARDCLIP, OCT SAW, MULTI TRI, MULTI SIN, SUB OSC SAW, SUB OSC SQU, SUB OSC TRI, SUB OSC SIN, LEVEL BOOST

Multi-mode filters

Filter 1 -24 dB/oct LPF—12 dB/oct LPF—HPF—BPF—Thru

Filter 2 LPF, HPF, BPF

Vocoder 16-band vocoder, adjustable level and pan for each band, Formant Shift function, Formant Hold function

Keyboard 37-note (Natural Touch Mini Keyboard, velocity sensitive, no aftertouch)

Effects

Timbre 2-band EQ

Master Master effects (17 effect algorithms)

Arpeggiator UP, DOWN, ALT1/2, Random, Trigger (6 types), Step Arpeggiator function

Programs 128 programs (banks A/B x 8 genres x 8 categories)

Input/output

Input AUDIO IN [LINE] jack, AUDIO IN [MIC] jack

AUDIO IN [LINE] jack

Maximum input level -17 dBu @ GAIN: Max.

Input impedance 7k-ohms

Connector 1/4" phone jack (unbalanced)

AUDIO IN [MIC] jack

Maximum input level -34 dBu @ GAIN: Max.

Input impedance 14 k-ohms

Connector XLR (balanced)

Output

L/MONO, R jacks

Maximum output level +4 dBu @ 10 k-ohm load

Output impedance 1 k-ohm

Connectors 1/4" phone jacks (unbalanced)

HEADPHONE jack

Maximum output level 10 + 10 mW @ 32 ohms load

Output impedance 10 ohms

Connector 1/4" stereo phone jack

MIDI IN, OUT

USB connector B type

Display Custom LCD

Power supply DC9V

When using batteries Six AA alkaline batteries

Battery life Approximately 4 hours

Dimensions (W x D x H) 556 x 231 x 73 mm / 21.89 x 9.09 x 2.87 inches

Weight 2 kg / 4.41 lbs

Included items AC Adapter, Gooseneck microphone

* Specifications and appearance are subject to change without notice for improvement.

5. Index

- A**
- AC adapter..... 10
 - ADSR 46
 - Amp (AMP)..... 19, 20
 - ARPEGGIATOR 21, 26, 82
 - Arpeggio parameter..... 52
 - ASSIGN 34
- B**
- Backlight..... 59
 - Battery 10
- C**
- Carrier (CARRIER) 21, 22, 25
 - CATCH 24
 - COMPLETE 31
 - Connection 9
 - CONTROL CHANGE..... 82
 - Controller 19
 - CROSS MODULATION 20, 36
 - Cutoff frequency..... 42
- D**
- Data Dump 28
 - Demo song 12, 98
 - Detune 35
 - DRIVE 20
- E**
- Effect 63
 - EG 19, 20, 46
- F**
- Envelope generators 20
 - EQ 20, 51
 - Equalizer 20, 51
 - External audio input 26
- G**
- Global setting..... 27
- I**
- INC/DEC function..... 23
 - Included mic..... 9
 - Infinite staircase 39
- K**
- Keyboard track..... 19
 - KNOB 34
 - KNOB MODE 24
- L**
- LAYER 32
 - LCD Backlight mode 59
 - LFO 19, 20, 48
 - Local setting ON/OFF 59
- M**
- Master effect (MASTER FX) 20, 51
 - MIDI 80
 - MIDI channel 81
 - MIDI Filter 60, 82
 - MIDI message..... 83
- N**
- MIDI parameter 59
 - Mixer 20
 - Modulator
(MODULATOR)..... 21, 22, 25
 - MULTI 32
 - Multi-timbral..... 81
- O**
- Noise generator 20
 - NRPN 86
- P**
- OSC 20, 36
 - Oscillator 19, 20
- P**
- Parameter 23
 - Performance edit..... 22
 - Pitch 35
 - Portamento 36
 - PRELOAD 30, 62
 - Program 19
 - Initializing a program 28
 - Program name 32
 - Program List 96
 - PROTECT 59
 - Pulse wave 38
- R**
- Restoring the factory setting .. 29, 62
 - ROUTING 43
- S**
- Saving..... 31
 - Sawtooth wave 38
- T**
- Sine wave 38
 - SINGLE 32
 - SPLIT 32
 - Step arpeggiator..... 26
 - Synthesizer..... 19
- T**
- Tempo..... 18
 - Timbre 19, 24
 - Copying a timbre 28
 - Timbre parameter 32
 - Triangle wave..... 38
- U**
- Unison..... 20
 - Unison function..... 35
 - USB..... 81
- V**
- Variable Phase Modulation..... 20
 - Virtual Patch 19, 20, 49
 - Vocoder..... 21, 25, 55
 - Vocoder section 21
 - VPM..... 20
- W**
- WAVEFORM 36
 - Waveshaping 20
 - WRITE 31
 - WS 20

IMPORTANT NOTICE TO CONSUMERS

This product has been manufactured according to strict specifications and voltage requirements that are applicable in the country in which it is intended that this product should be used. If you have purchased this product via the internet, through mail order, and/or via a telephone sale, you must verify that this product is intended to be used in the country in which you reside. **WARNING:** Use of this product in any country other than that for which it is intended could be dangerous and could invalidate the manufacturer's or distributor's warranty. Please also retain your receipt as proof of purchase otherwise your product may be disqualified from the manufacturer's or distributor's warranty.